

# LAUNCH SUPPLIES

To launch your rocket you will need the following items:

- Estes Launch Control System
- Estes Recovery Wadding (No. 2274)
- Recommended Engines: 1/2A6-2, A8-5, B4-4, B4-6, B6-4, B6-6, B8-5, C6-5, C6-7

Use 1/2A6-2 engine for your first flight to become familiar with your rocket's flight pattern. Use only with Estes products.

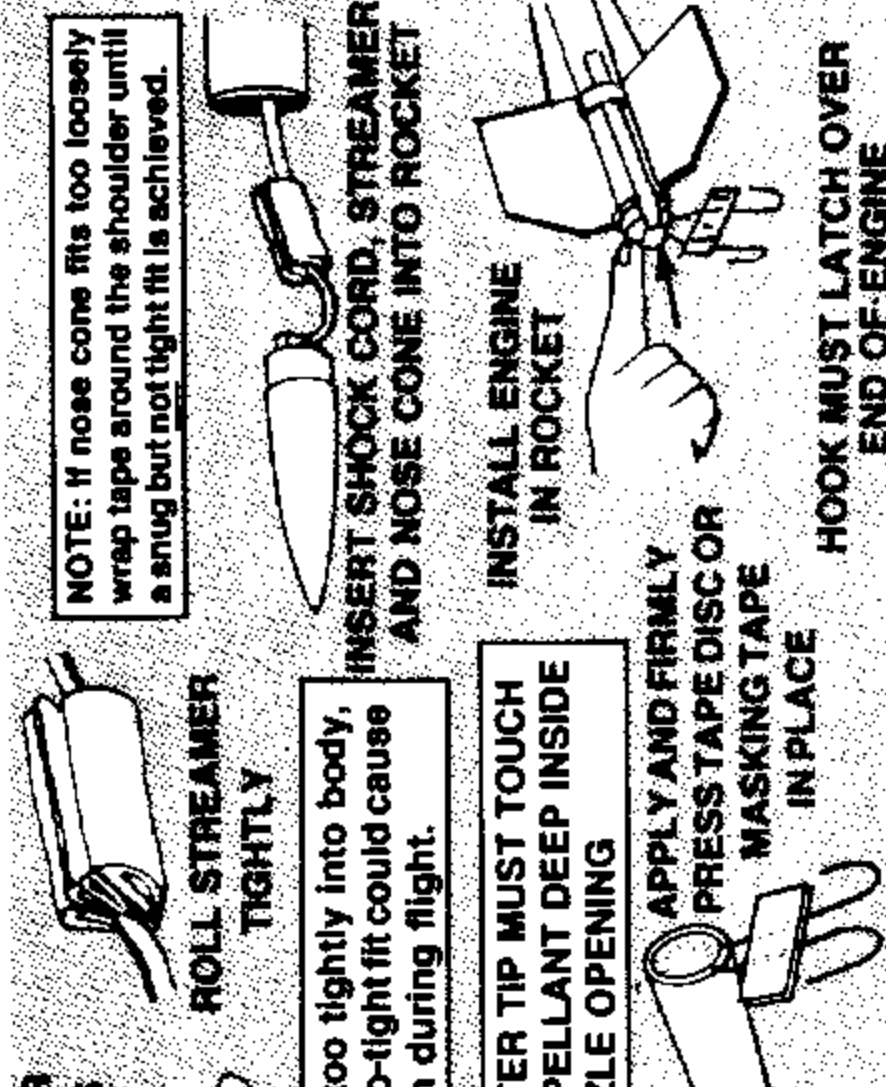

# COUNTDOWN AND LAUNCH

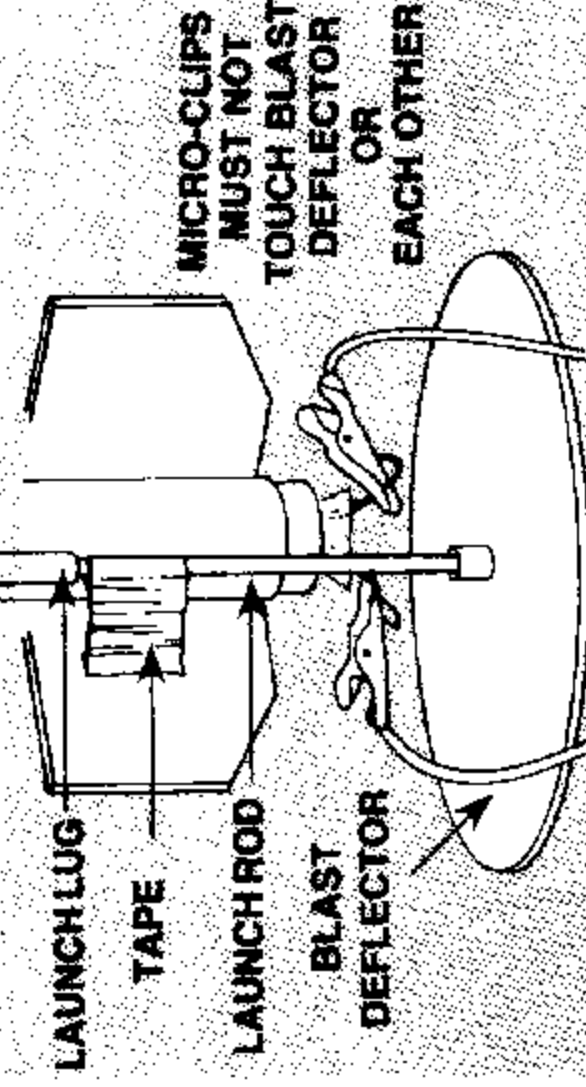

- 10 REMOVE SAFETY KEY to disarm the launch controller.
- 9 Remove safety cap and slide launch lug over launch rod to place rocket on launch pad. Make sure the rocket slides freely on the launch rod.
- 8 Attach micro-clips to the igniter wires. Arrange the clips so they do not touch each other or the metal blast deflector. Attach clips as close to protective tape on igniter as possible.
- 7 Move back from your rocket as far as launch wire will permit, (at least 15 feet).
- 6 INSERT SAFETY KEY to arm the launch controller. Give audible countdown... 5 . . 4 . . 3 . . 2 . . 1 . .

# LAUNCH!!!

Remove safety key— Replace cap on launch rod.



#2005

ESTES INDUSTRIES  
1295 H STREET  
PENROSE, CO 81240 USA

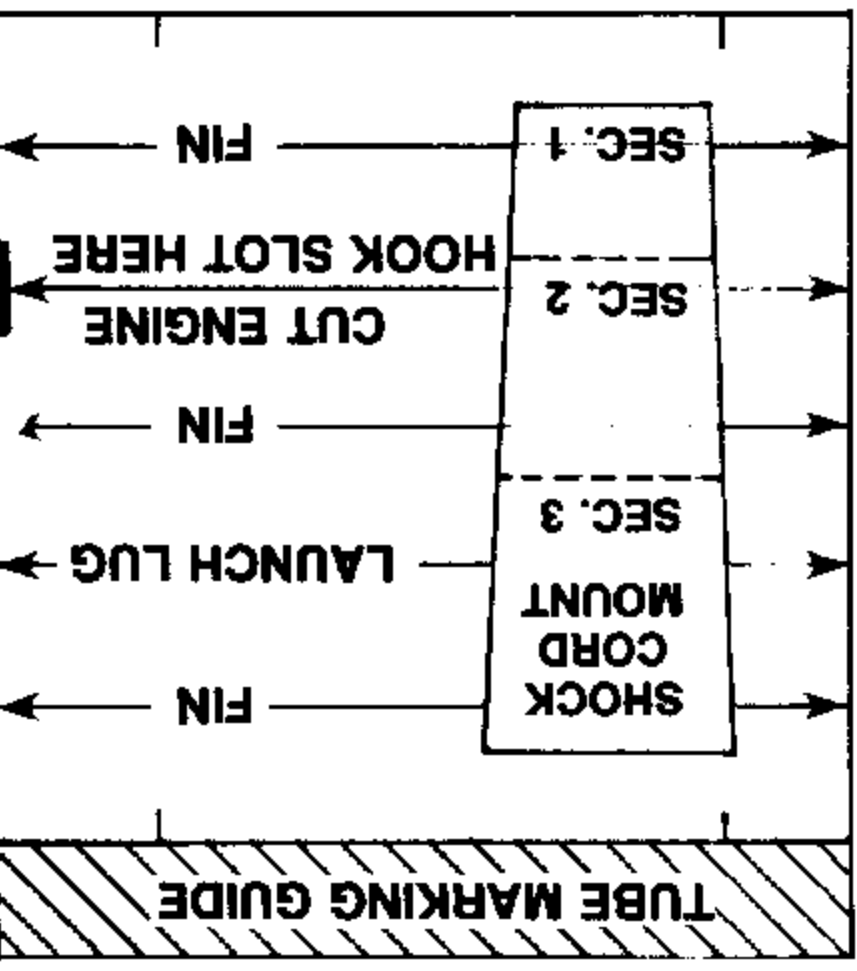

# ASSEMBLY TIP

Read all instructions before beginning work on your model. Make sure you have all parts and supplies. Test-fit all parts together before applying any glue. If any parts don't fit properly, sand as required for precision assembly.

# PARTS AND SUPPLIES

Locate the parts shown below and lay them out on the table in front of you. In addition to the parts included in the kit you will also need:

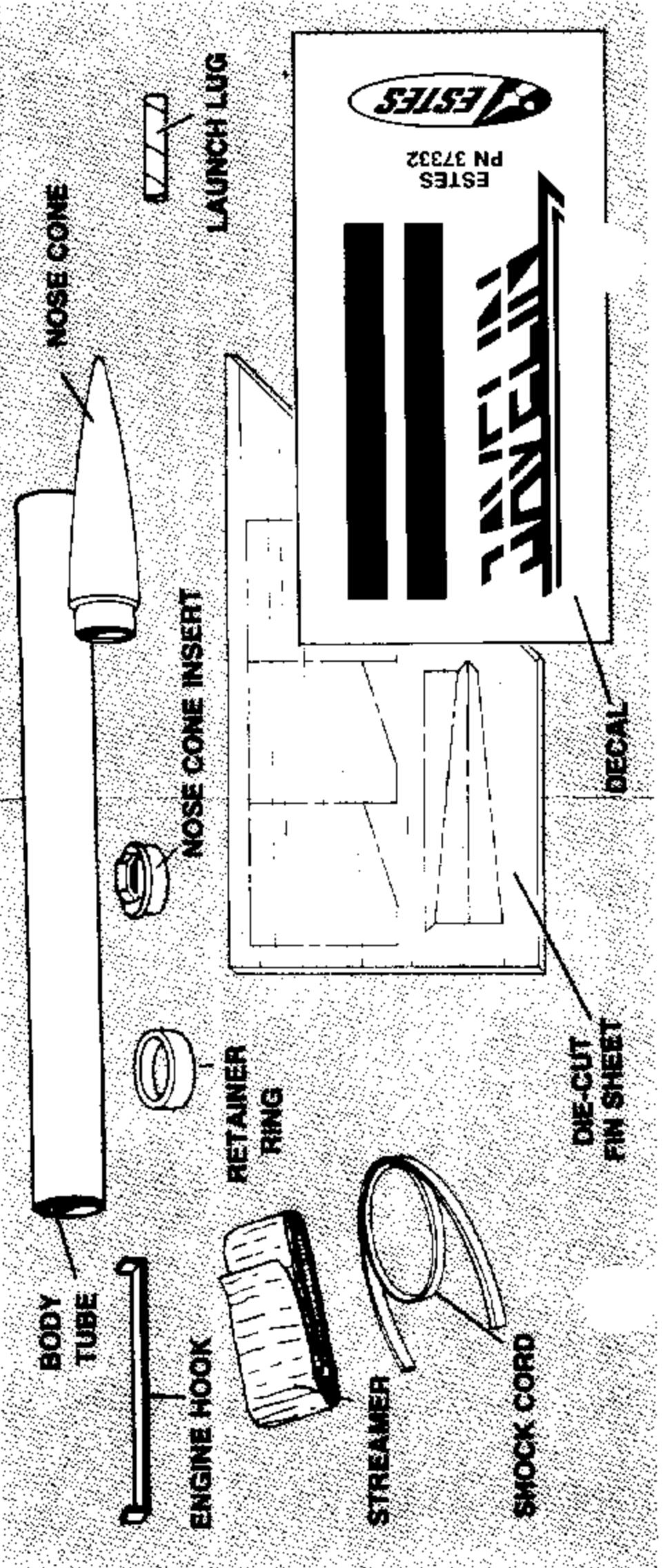
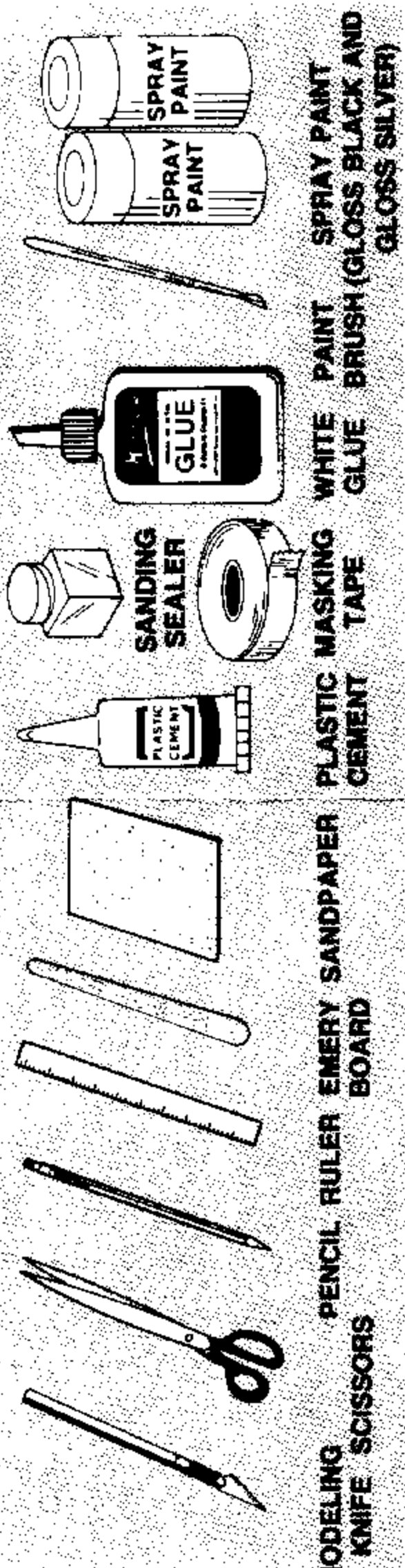

# SAFETY

ities. erica

## DECALS

Let paint dry overnight before applying decals. To apply decals, cut each out, dip in lukewarm water for 20 seconds, and hold until it uncurls. Refer to photograph on front page and/or on front of panel for decal placement. Slip decal off backing sheet and onto model. Blot away excess water. For best results, let decals dry overnight.

## ROCKET PREFLIGHT

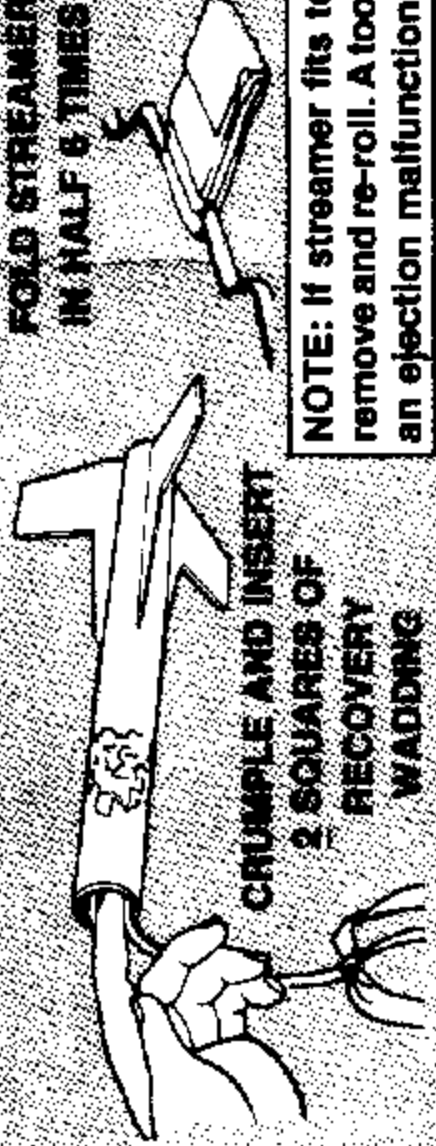

## PREPARE ENGINE

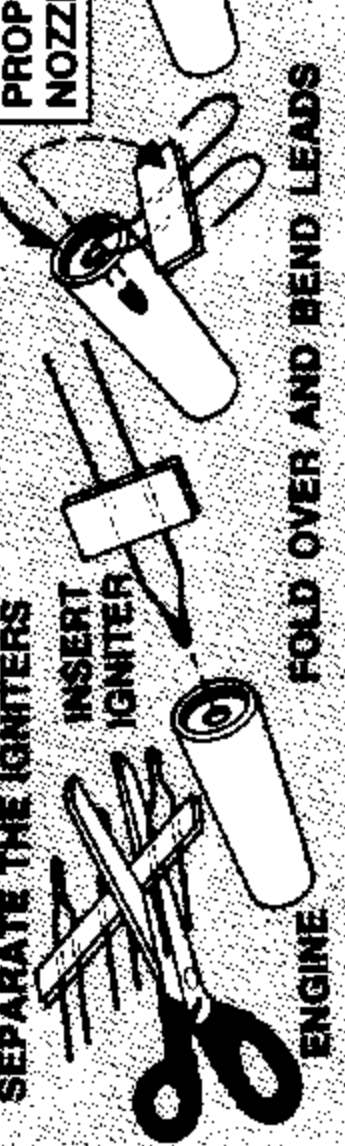

## FLYING YOUR ROCKET

Choose a large field away from power lines, tall trees, and low flying aircraft. Try to find a field at least 250 feet square. The larger the launch area, the better your chance of recovering your rocket. Football fields and playgrounds are great. Launch area must be free of dry weeds and brown grass. Launch only during calm weather with little or no wind and good visibility. Wrap a 2" piece of tape around launch rod 3" above blast deflector, to hold rocket and engine above blast deflector.

## MISFIRES

Failure of the model rocket engine to ignite is nearly always caused by incorrect igniter installation. An Estes igniter will function properly even if the coated tip is chipped. However if the coated tip is not in direct contact with the engine propellant, it will only heat and not ignite the engine. When an ignition failure occurs, remove the safety key from the launch control system and wait one minute before approaching the rocket. Remove the expended igniter from the engine and install a new one. Be certain the coated tip is in direct contact with the engine propellant, then tape the igniter leads firmly to base of engine as illustrated above. Repeat the countdown and launch procedure.

## FOR YOUR SAFETY AND ENJOYMENT

Always follow the NAR-HIA MODEL ROCKETRY SAFETY CODE while participating in any model rocketry activities. \*National Association of Rocketry-The Hobby Industry of America

## LAUNCH SUPPLIES

To launch your rocket you will need the following items:  
 —Estes Launch Control System  
 —Estes Recovery Wadding (No. 2274)  
 —Recommended Engines: 1/2A6-2, A8-5, B4-4, B4-6, B6-4, B6-6, B8-5, C6-5, C6-7  
 Use 1/2A6-2 engine for your first flight to become familiar with your rocket's flight pattern. Use only with Estes products.

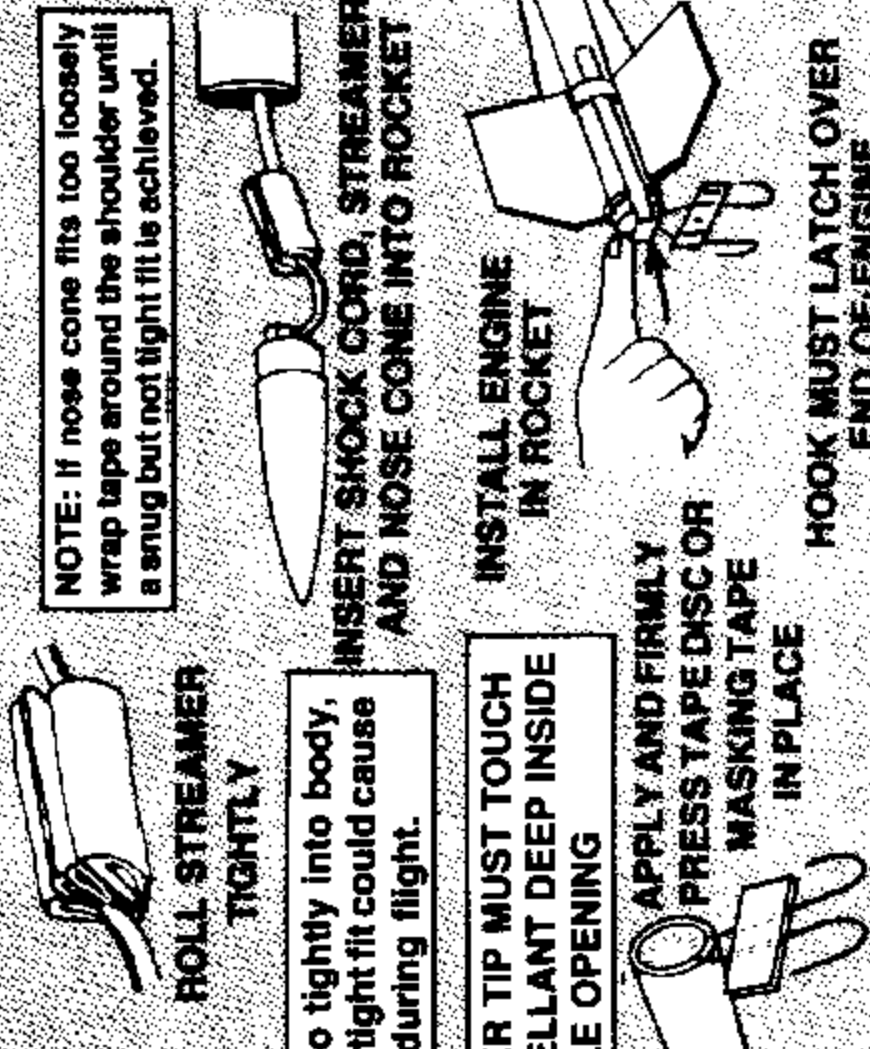

## COUNTDOWN AND LAUNCH

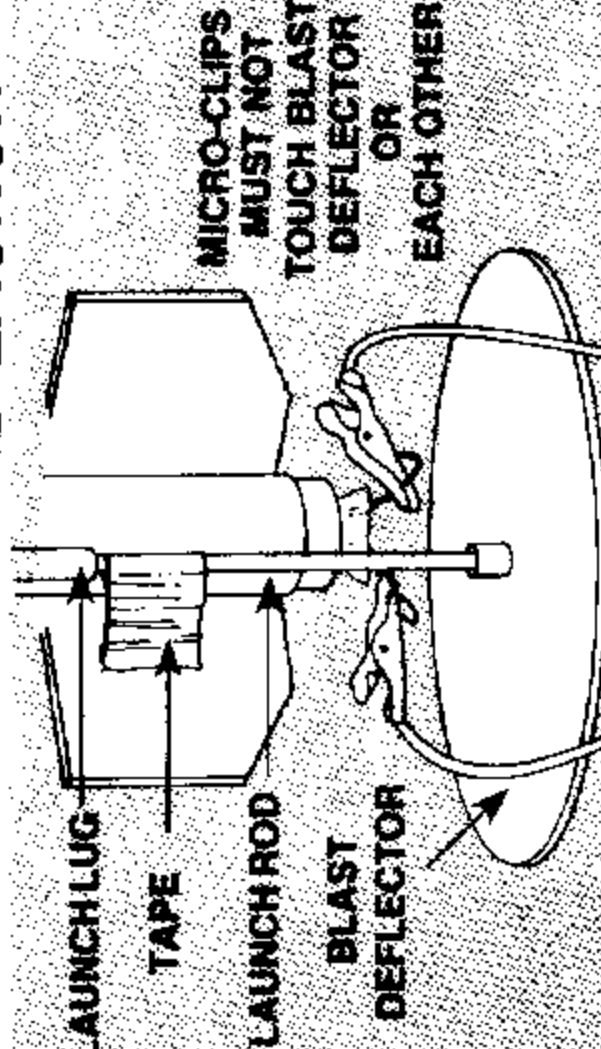

- 10 REMOVE SAFETY KEY to disarm the launch controller.
- 9 Remove safety cap and slide launch lug over launch rod to place rocket on launch pad. Make sure the rocket slides freely on the launch rod.
- 8 Attach micro-clips to the igniter wires. Arrange the clips so they do not touch each other or the metal blast deflector. Attach clips as close to protective tape on igniter as possible.
- 7 Move back from your rocket as far as launch wire will permit, (at least 15 feet).
- 6 INSERT SAFETY KEY to arm the launch controller. Give audible countdown... 5 . . . 4 . . . 3 . . . 2 . . . 1 . . .

## LAUNCH!!!

Remove safety key— Replace cap on launch rod.



ESTES INDUSTRIES  
 1295 H STREET  
 PENROSE, CO 81240 USA

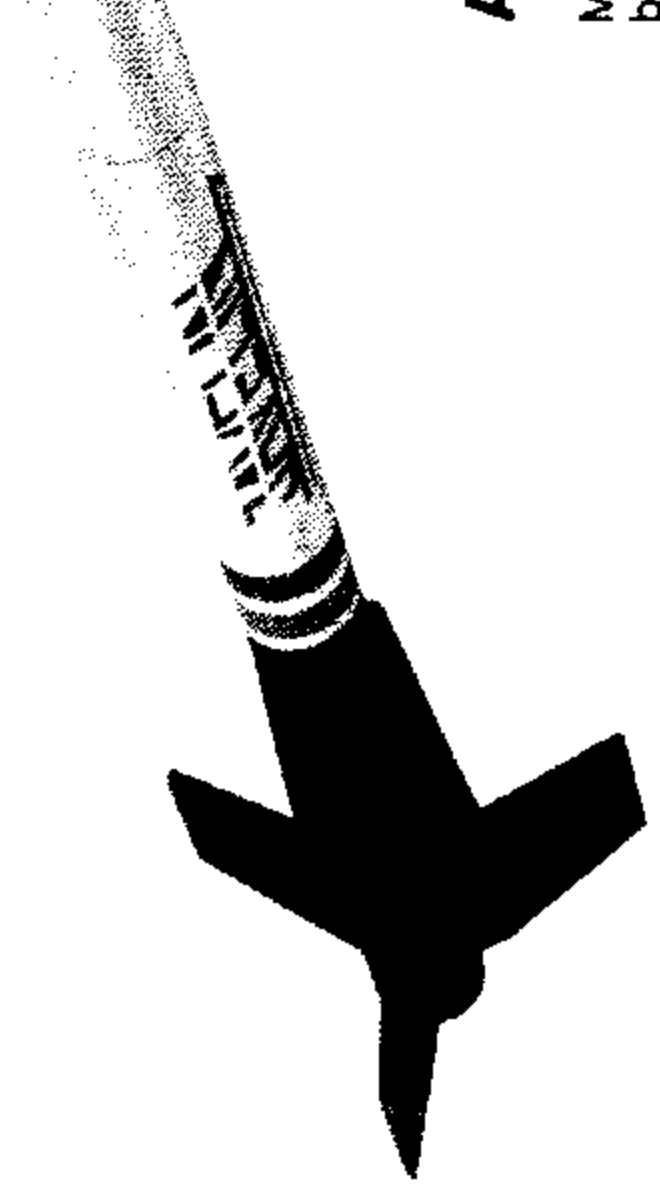

## PARTS AND SUPPLIES

Locate the parts shown below and lay them out on the table. Make before you begin. The kit you will also need:

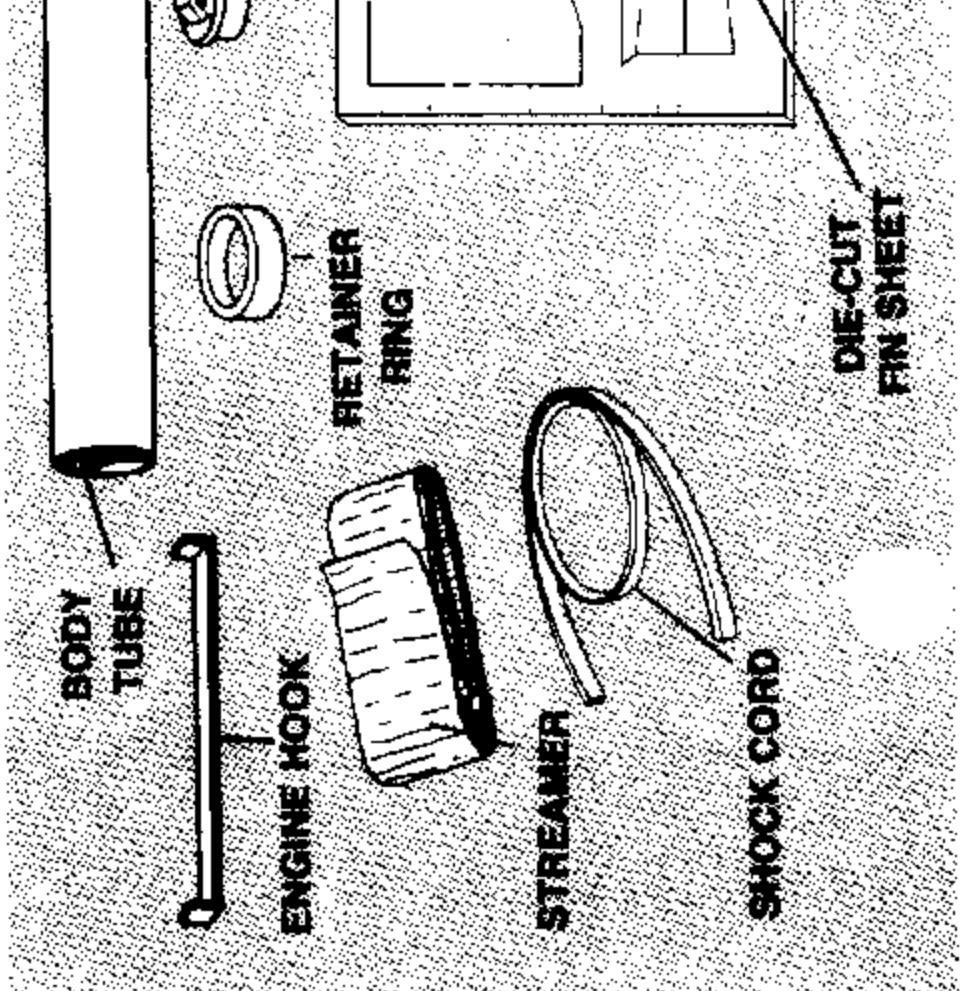
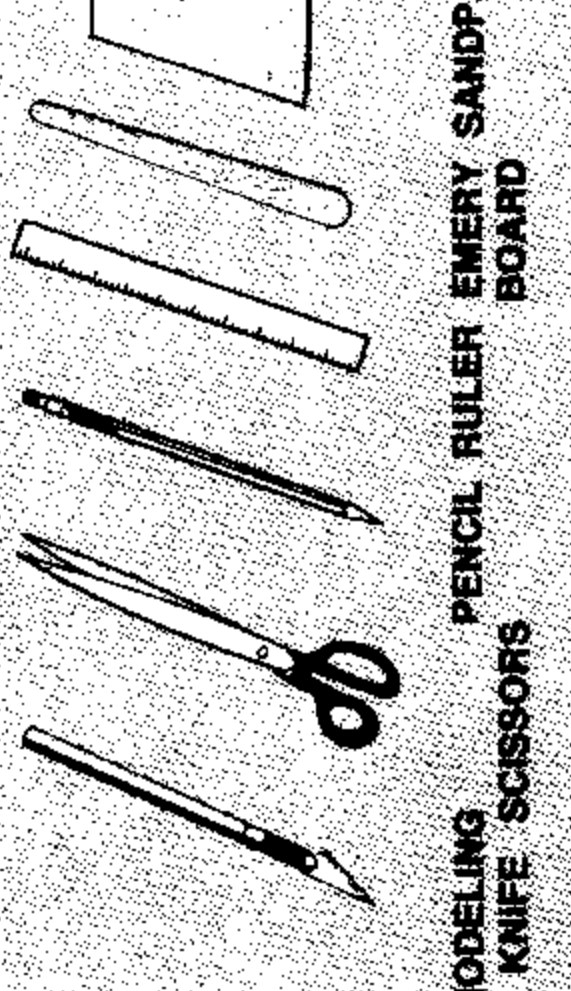

# ROCKET ASSEMBLY

- 1**
  - A. Cut out tube marking guide from front page.
  - B. Wrap guide around tube 1/8 inch from one end and tape.
  - C. Mark tube at arrows. Mark launch lug line. Do not remove guide.
- 2**
  - A. Cut 1/8 inch wide engine hook slit in tube next to mark on tube marking guide.
  - B. Remove guide and save for step # 7.
  - C. Extend lines 6 inches long for fins and launch lug.
- 3**
  - A. Make a mark 1 1/8 inch from fin end of tube.
  - B. Apply a bead of glue around tube 3/8 inch in front of this mark.
  - C. Push one end of engine hook into slot and lay hook straight along tube.
  - D. Slide retainer ring over engine hook and glue, position edge of ring at 1 1/8" mark as shown.
  - E. Add glue reinforcement to engine hook as shown.
- 4**
  - A. Carefully remove fins from die cut sheet using modeling knife.
  - B. With emery board, notch root edge of 3 larger fins 5/16 inch as shown.
  - C. Put a small film of glue along fin root edge.
  - D. Place fin on body tube fin line.
  - E. Remove fin and allow 15 seconds for glue to become tacky.
  - F. Add a bit more glue and place back on fin line. Hold fin in place till glue sets. Repeat for remaining two fins.
- 5**
  - A. Glue on the three remaining long and narrow fins in the same sequence as in Step 4 C through F.

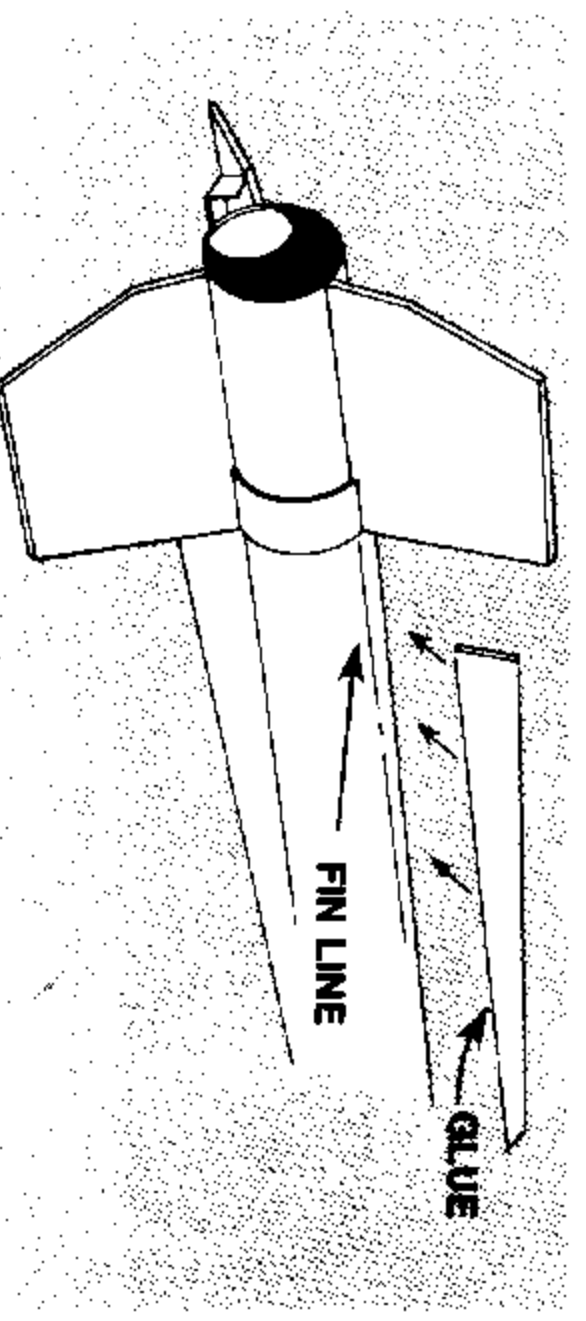
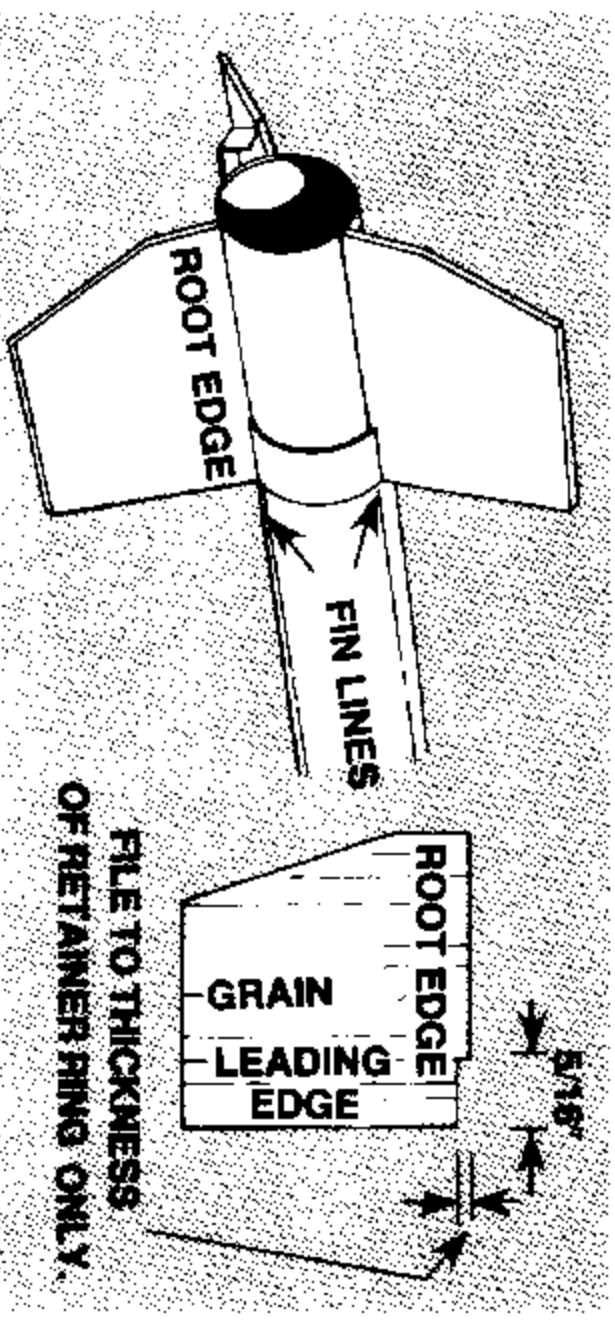
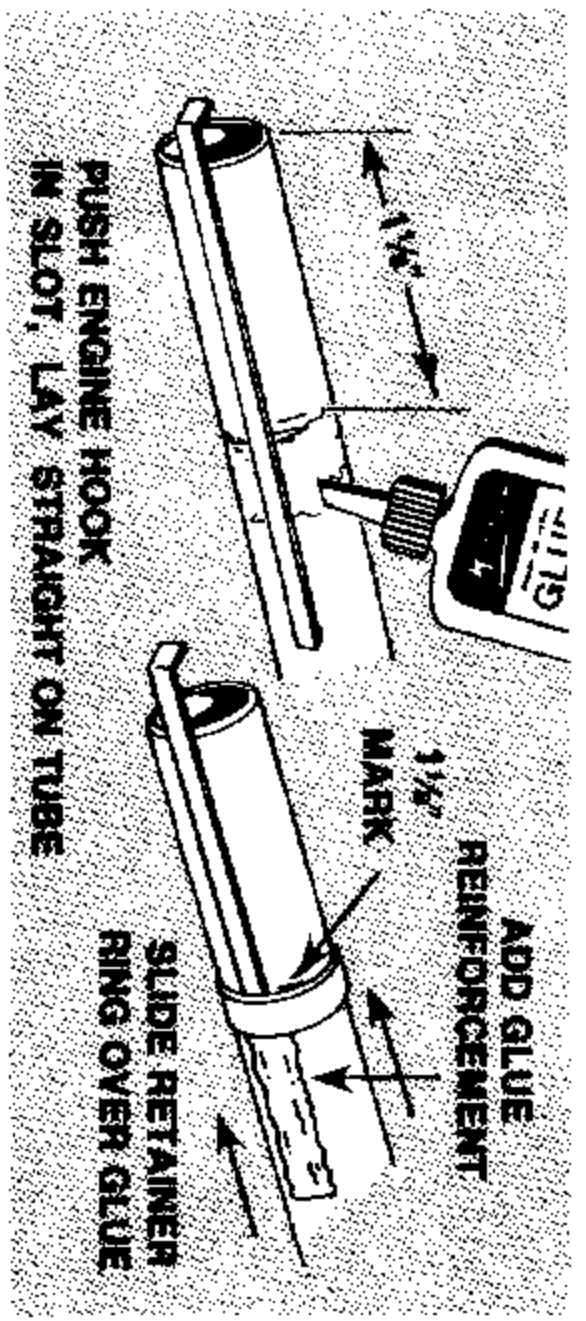
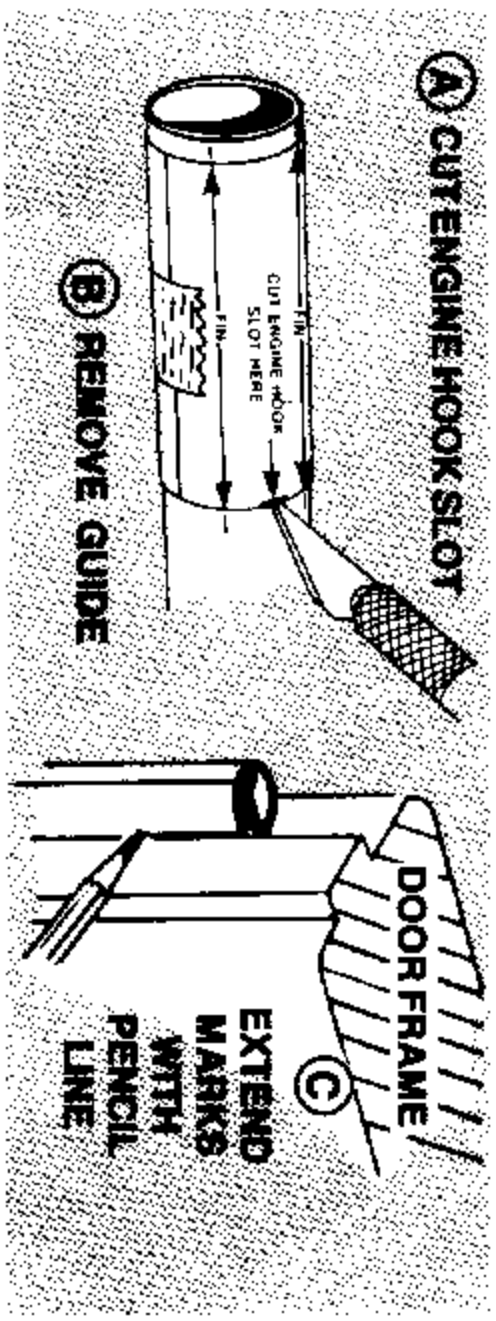
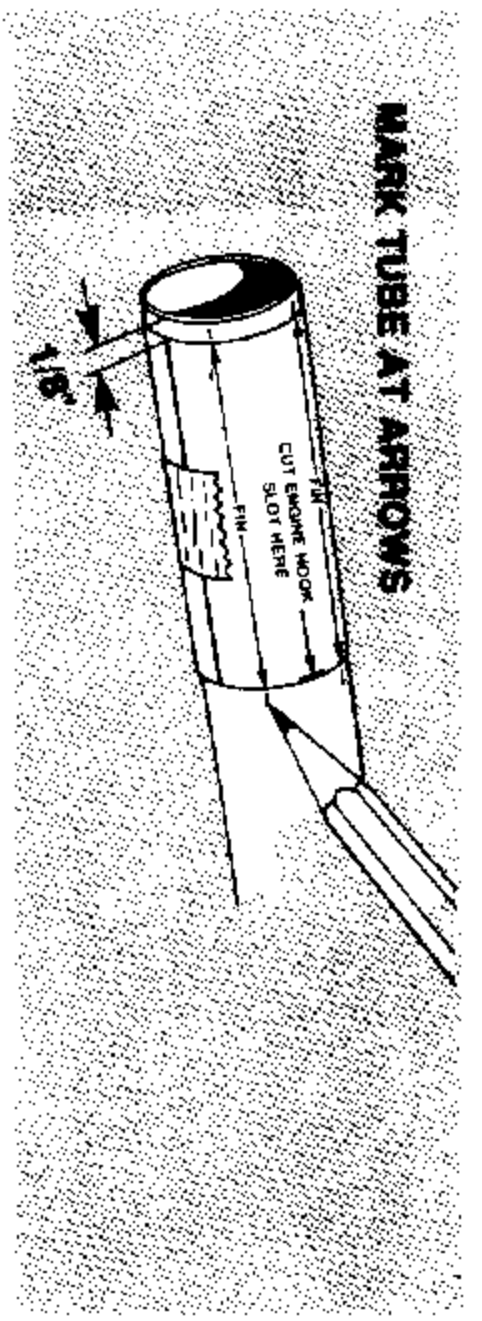

- 6.**
  - A. Glue launch lug straight on launch lug line with its rear edge against retainer ring.
  - B. Apply glue reinforcement to all fin joints and launch lug.

- 7**
  - A. Cut shock cord mount from tube marking guide.
  - B. Crease on dotted lines by folding. Spread glue on section 1 and lay end of shock cord into glue. Fold over and apply glue to back of first section and exposed part of section 2. Lay shock cord as shown and fold mount over again.
  - C. Clamp unit together with fingers until glue sets.

- 8**
  - A. Apply glue to inside front of body tube to cover an area no less than 1 inch to 2 inches from end. The glued area should be the same size as shock cord mount.
  - B. Press mount firmly into glue as shown.
  - C. Hold until glue sets.

- 9**
  - A. Assemble nose cone and nose cone insert with plastic cement.
  - B. When dry, tie free end of shock cord to nose loop with double knot.

- 10**
  - A. Cut a 1 inch long piece of 3/4 inch wide masking tape.
  - B. Lay end of shock cord over end of streamer material as shown, and tape shock cord and streamer together.
  - C. Press tape down firmly to assure a strong bond.

## FINISHING YOUR ROCKET

Apply sanding sealer to wood parts with brush. When sealer is dry, lightly sand all sealed surfaces. Repeat sanding and sanding until balsa grain is filled and smooth. Pair

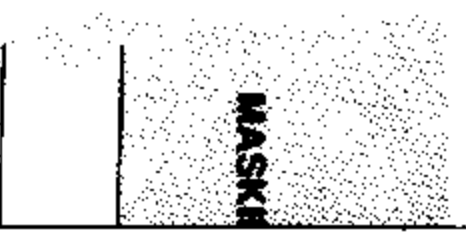
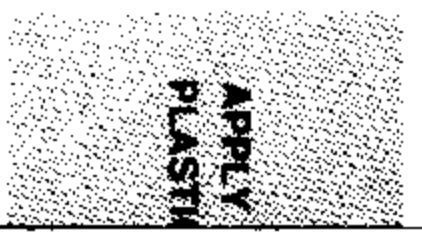
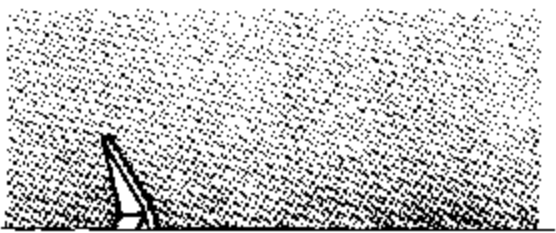

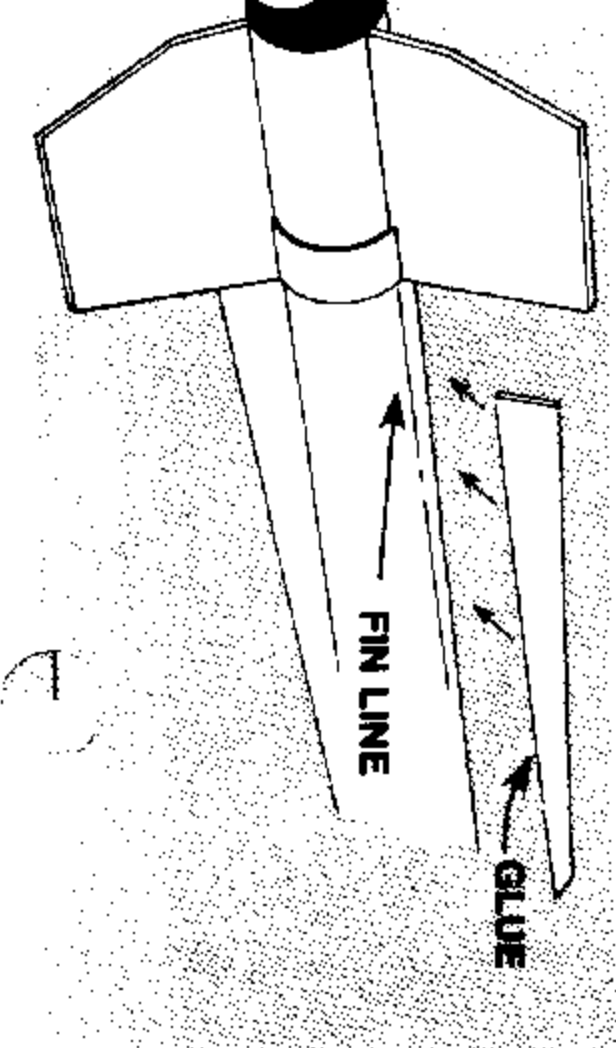
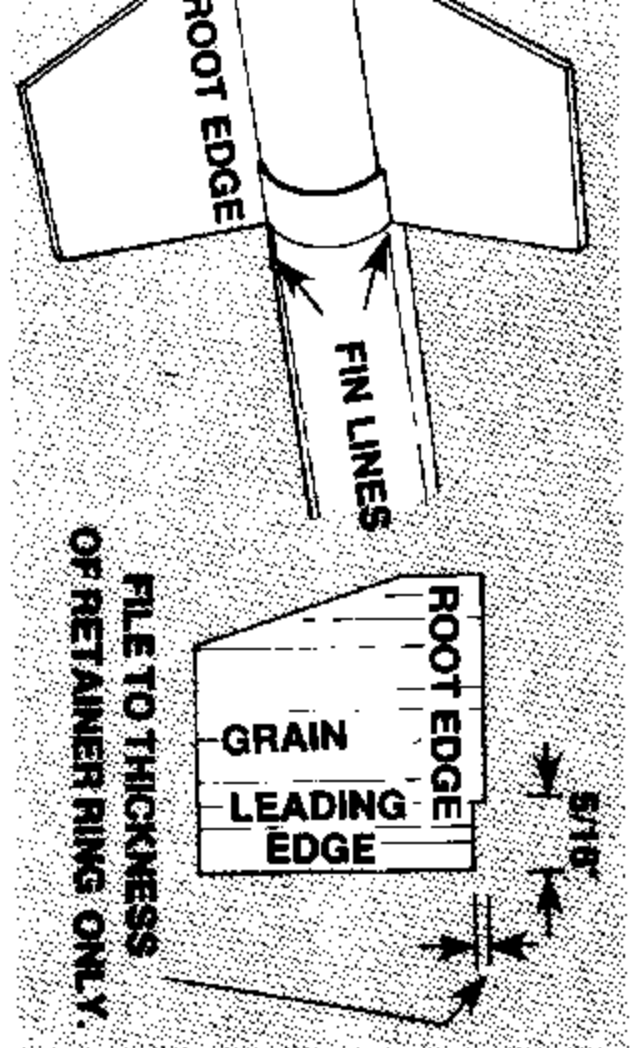
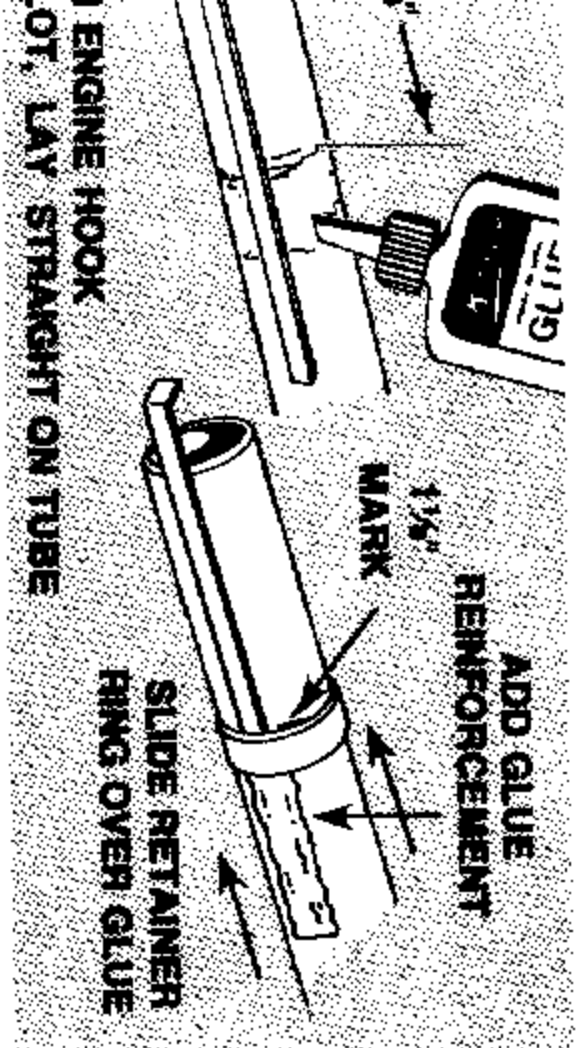
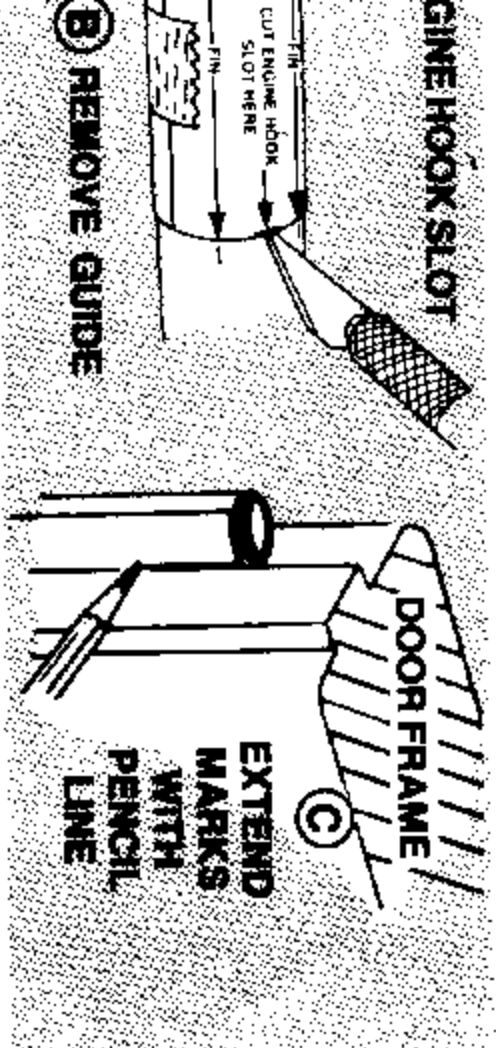
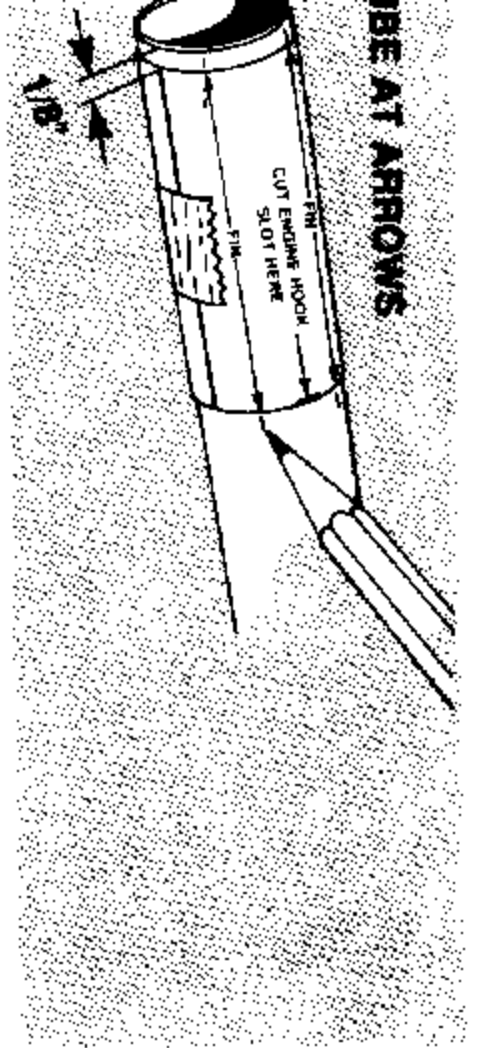

6. A. Glue launch lug straight on launch lug line with its rear edge against retainer ring.
- B. Apply glue reinforcement to all fin joints and launch lug.

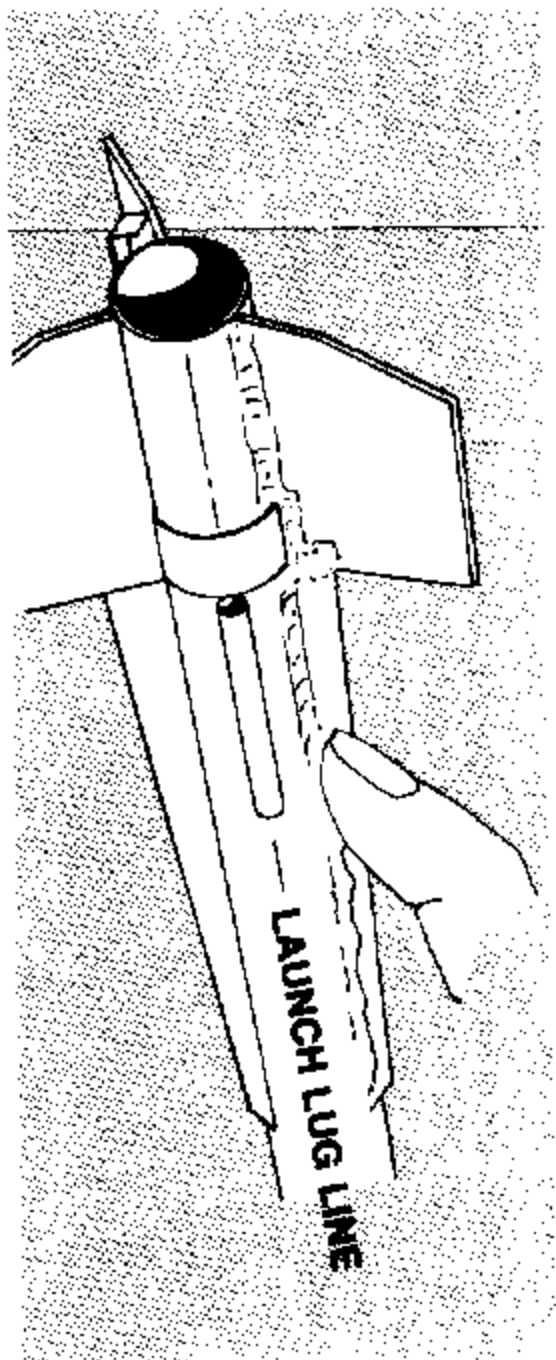

7. A. Cut shock cord mount from tube marking guide.
- B. Crease on dotted lines by folding. Spread glue on section 1 and lay end of shock cord into glue. Fold over and apply glue to back of first section and exposed part of section 2. Lay shock cord as shown and fold mount over again.
- C. Clamp unit together with fingers until glue sets.

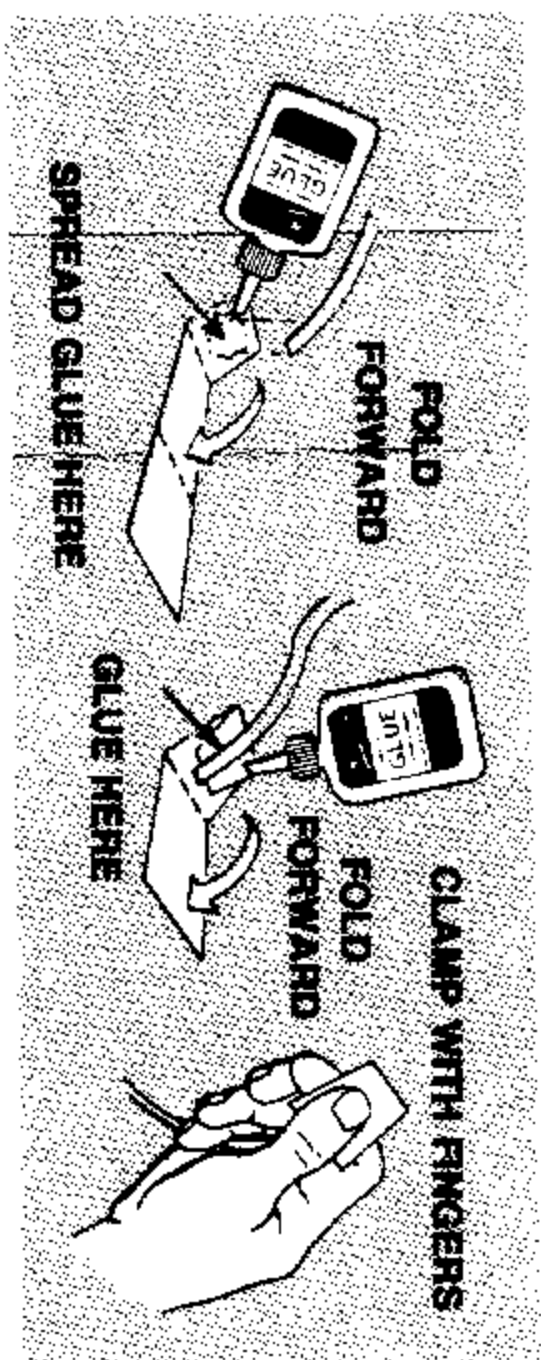

8. A. Apply glue to inside front of body tube to cover an area no less than 1 inch to 2 inches from end. The glued area should be the same size as shock cord mount.
- B. Press mount firmly into glue as shown.
- C. Hold until glue sets.

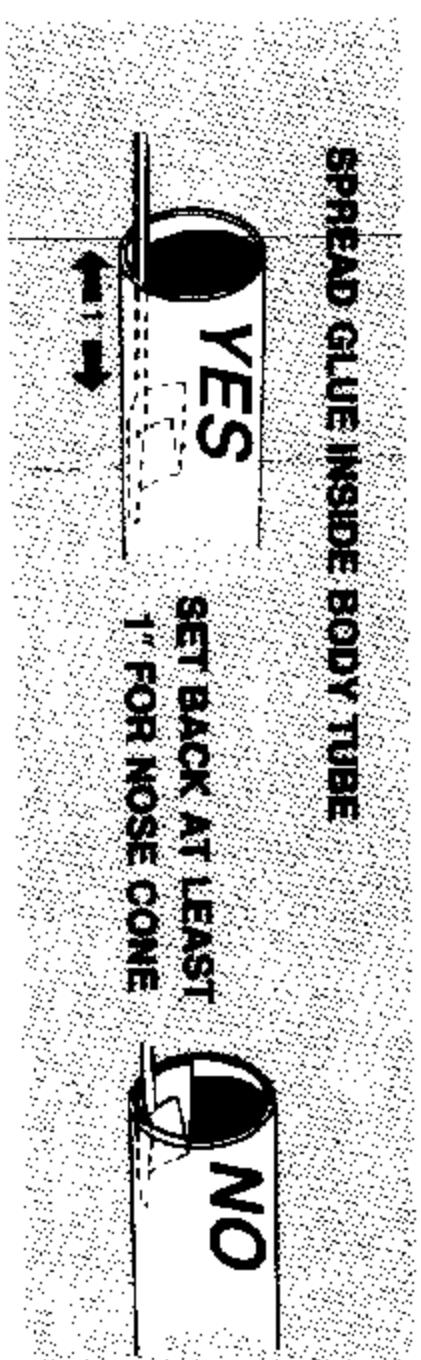

9. A. Assemble nose cone and nose cone insert with plastic cement.
- B. When dry, tie free end of shock cord to nose loop with double knot.

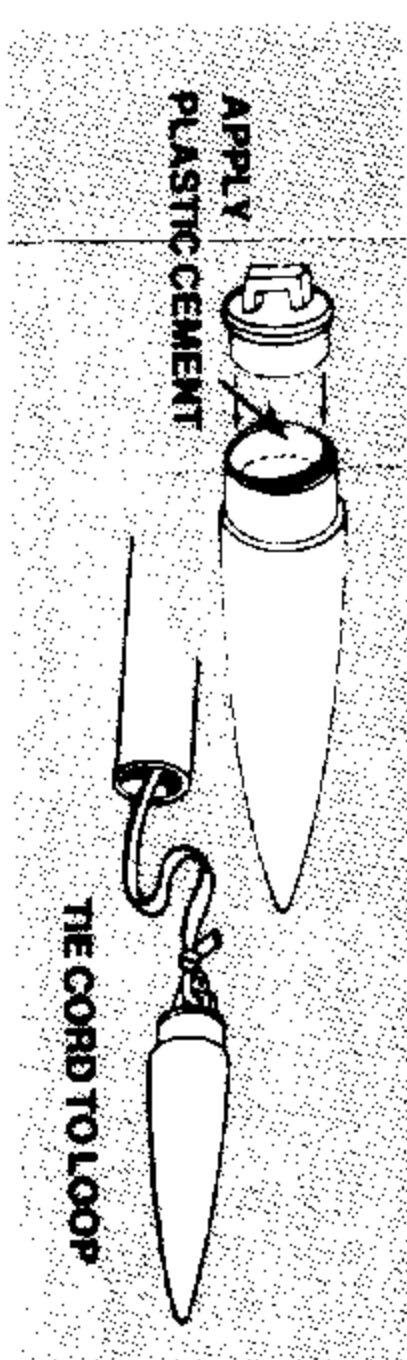

10. A. Cut a 1 inch long piece of 3/4 inch wide masking tape.
- B. Lay end of shock cord over end of streamer material as shown, and tape shock cord and streamer together.
- C. Press tape down firmly to assure a strong bond.

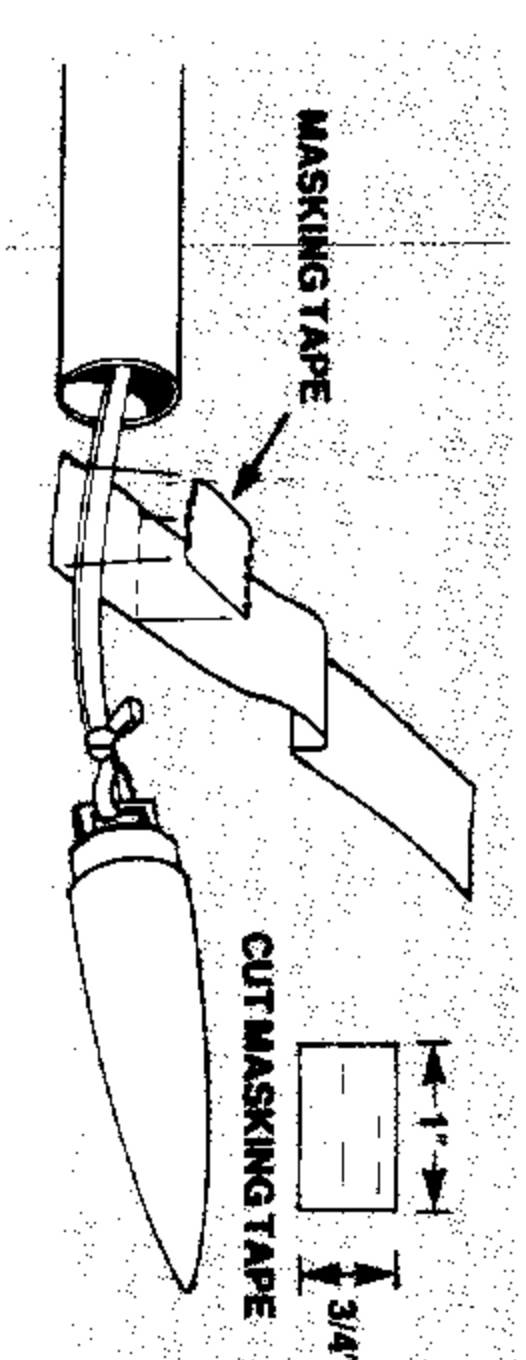

## FINISHING YOUR ROCKET

Apply sanding sealer to wood parts with brush. When sealer is dry, lightly sand all sealed surfaces. Repeat sealing and sanding until balsa grain is filled and smooth. Pair

spray enamel gloss silver and gloss black. Refer to the package panel for paint placement. The color change line is located 1/4 inch from the end of the long arrow fins.