

# Estes Industries Rocket Plan No. 41

## SPACE TWINS

### ASSEMBLE THE GLIDE - BOOSTER

1. Cut a slot in the BT-20B body tube 2-1/2" from one end just large enough to admit the front hook of the EH-2 engine holder. Apply a line of glue from the slot half way to the end of the body tube and lay the engine holder in place. Cut a 1/2" x 1-1/2" piece of typing paper and glue in place over the front half of the engine holder.

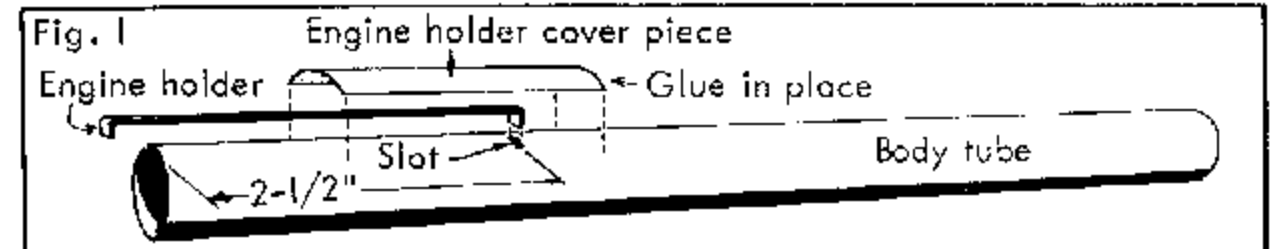

2. Slide the JT-20C into the body tube from the front. The center of the coupler should be 4" from the rear of the body tube. Drill a 1/8" hole straight thru the body tube and coupler. Ream this hole as necessary to slide a piece of 1/8" dowel (WD-1) into it at a 45° angle. Trim two pieces of dowel to the shape shown and glue them into place.

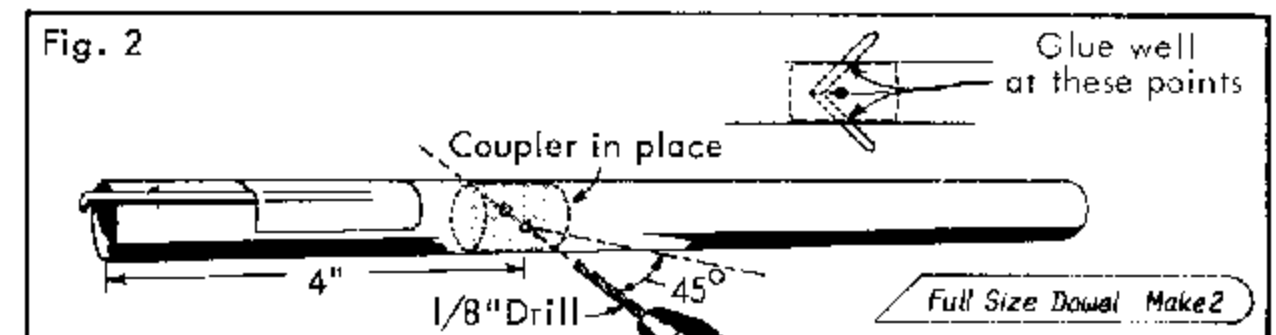

3. Trace the shock cord anchor piece (see pattern group) onto typing paper, cut out and prefold as shown. Attach this piece to one end of the shock cord following the 3 steps shown. Install the cord and anchor 3/4" into the front of the body tube. This job is made easier by using tweezers to put the unit into place, then rolling it against the inside of the body tube with a pencil or model knife handle.

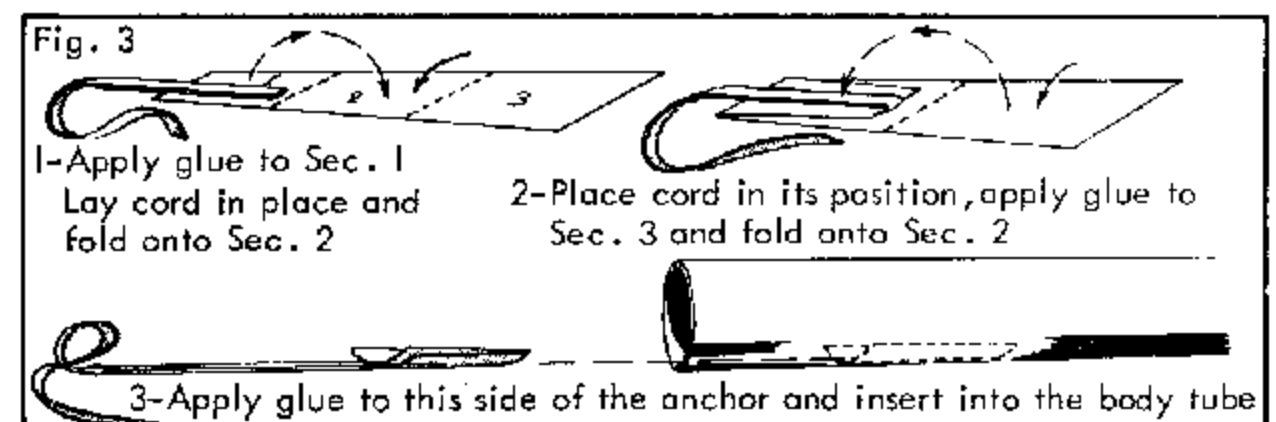

4. Thread the screw eye first thru the two nose cone weights, then into the base of the nose cone (BNC-20N). Remove only the nose cone and squirt glue into the hole and rethread the nose cone onto the screw eye until the base seats against the weights. Tape or tie on the free end of the shock cord to the screw eye.

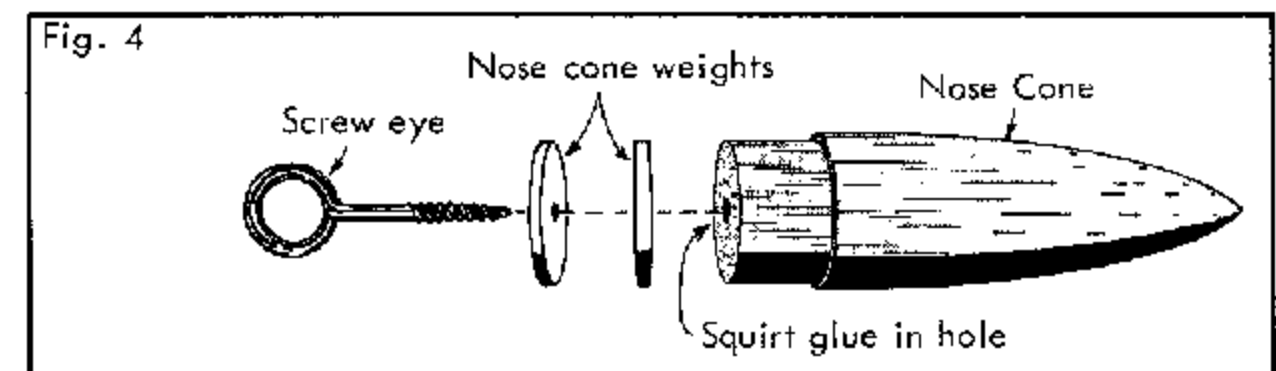

5. Prepare the parachute according to the instructions with the kit. Tie the shroud lines together at the free ends and pass the knot thru the screw eye. Divide the lines into 3's as shown, pass the nose cone up thru the "loop" thus formed and bring the lines and knot back to the screw eye and pull tight. (See the illustration.)

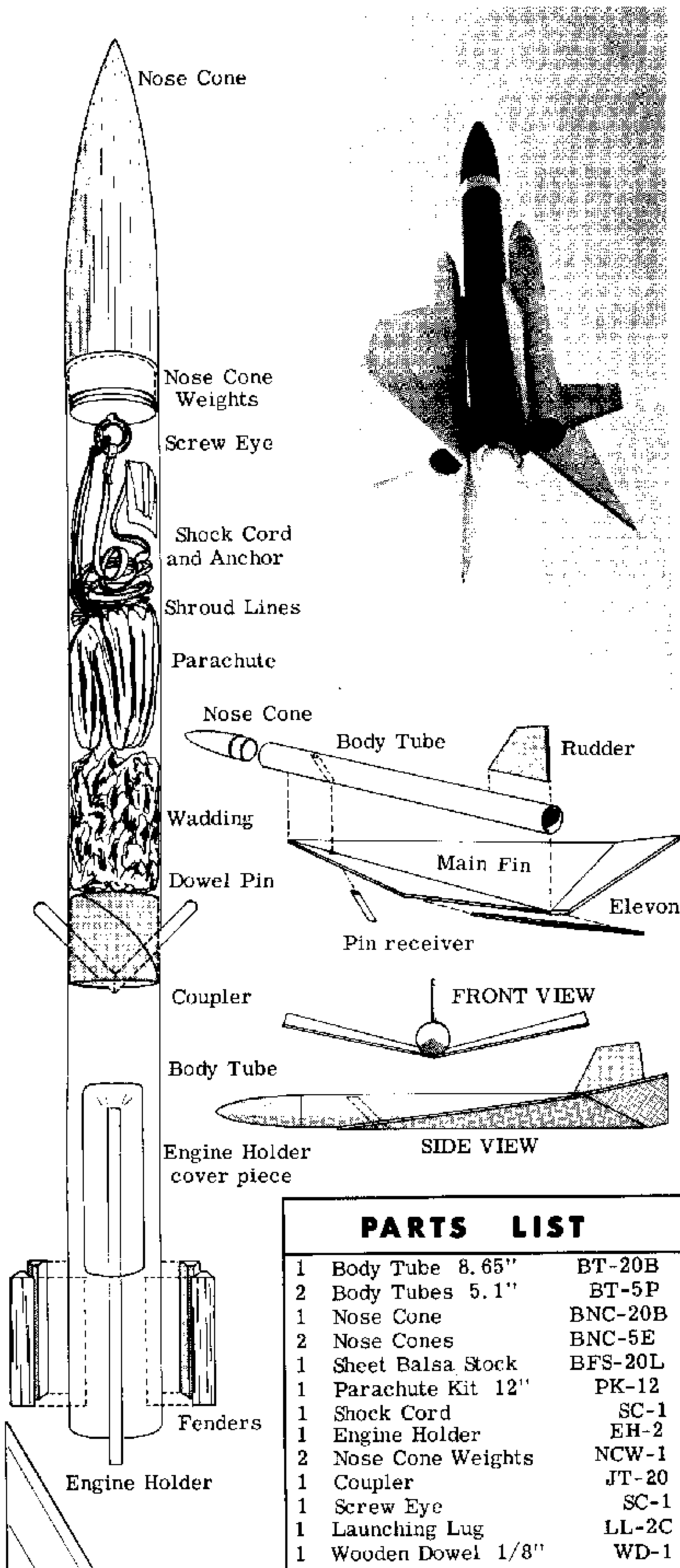
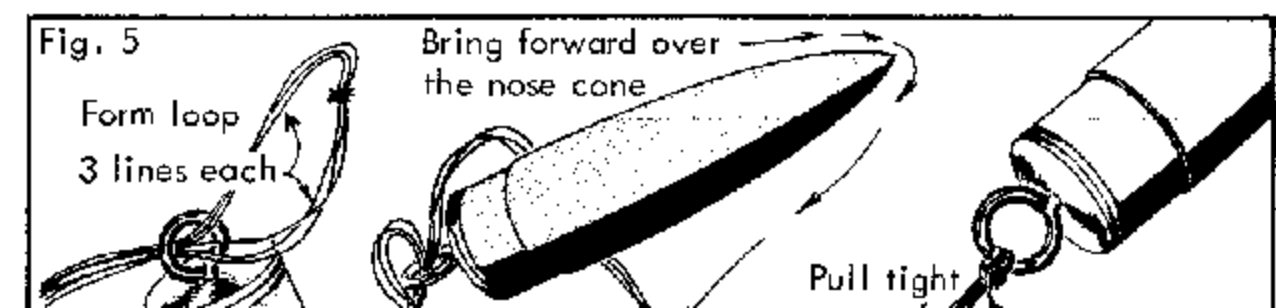

PARTS LIST		
1	Body Tube 8.65"	BT-20B
2	Body Tubes 5.1"	BT-5P
1	Nose Cone	BNC-20B
2	Nose Cones	BNC-5E
1	Sheet Balsa Stock	BFS-20L
1	Parachute Kit 12"	PK-12
1	Shock Cord	SC-1
1	Engine Holder	EH-2
2	Nose Cone Weights	NCW-1
1	Coupler	JT-20
1	Screw Eye	SC-1
1	Launching Lug	LL-2C
1	Wooden Dowel 1/8"	WD-1

### PATTERN GROUP

Trace onto heavy paper or card stock. Cut out and use as layout templates.

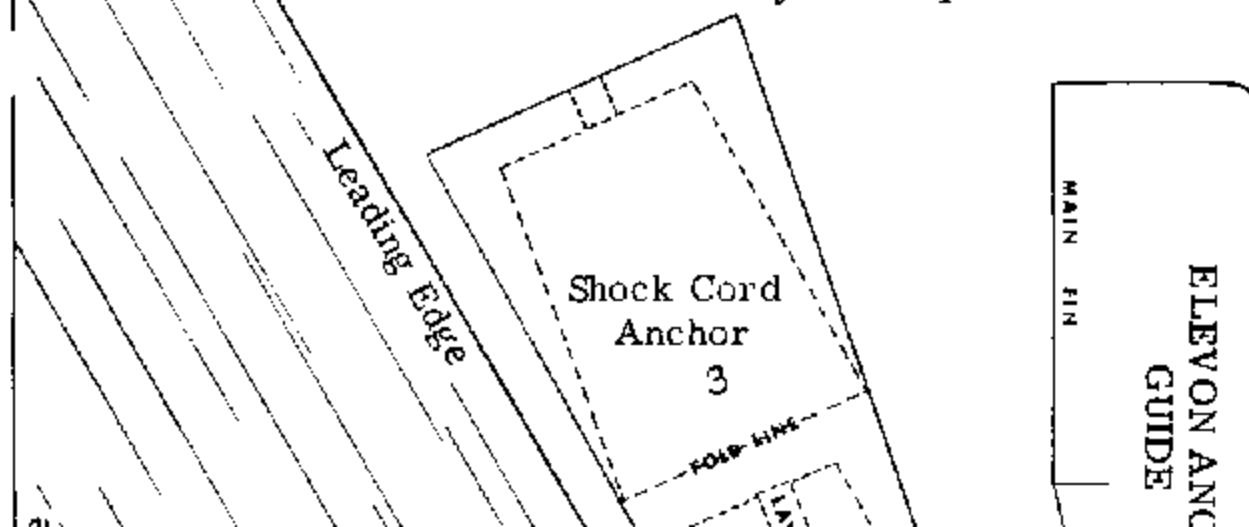

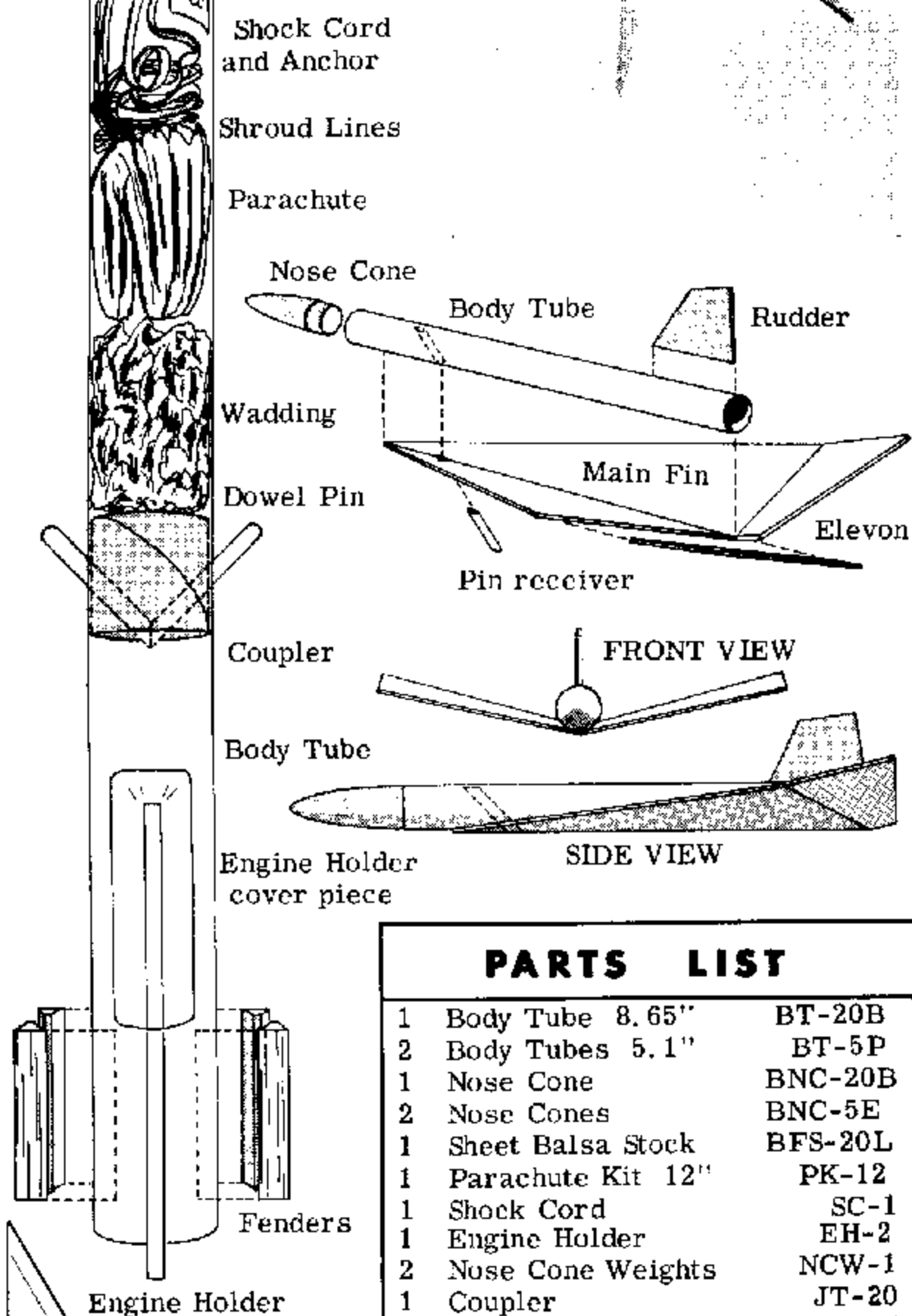

PARTS LIST		
1	Body Tube 8.65"	BT-20B
2	Body Tubes 5.1"	BT-5P
1	Nose Cone	BNC-20B
2	Nose Cones	BNC-5E
1	Sheet Balsa Stock	BFS-20L
1	Parachute Kit 12"	PK-12
1	Shock Cord	SC-1
1	Engine Holder	EH-2
2	Nose Cone Weights	NCW-1
1	Coupler	JT-20
1	Screw Eye	SC-1
1	Launching Lug	LL-2C
1	Wooden Dowel 1/8"	WD-1

### PATTERN GROUP

Trace onto heavy paper or card stock. Cut out and use as layout templates.

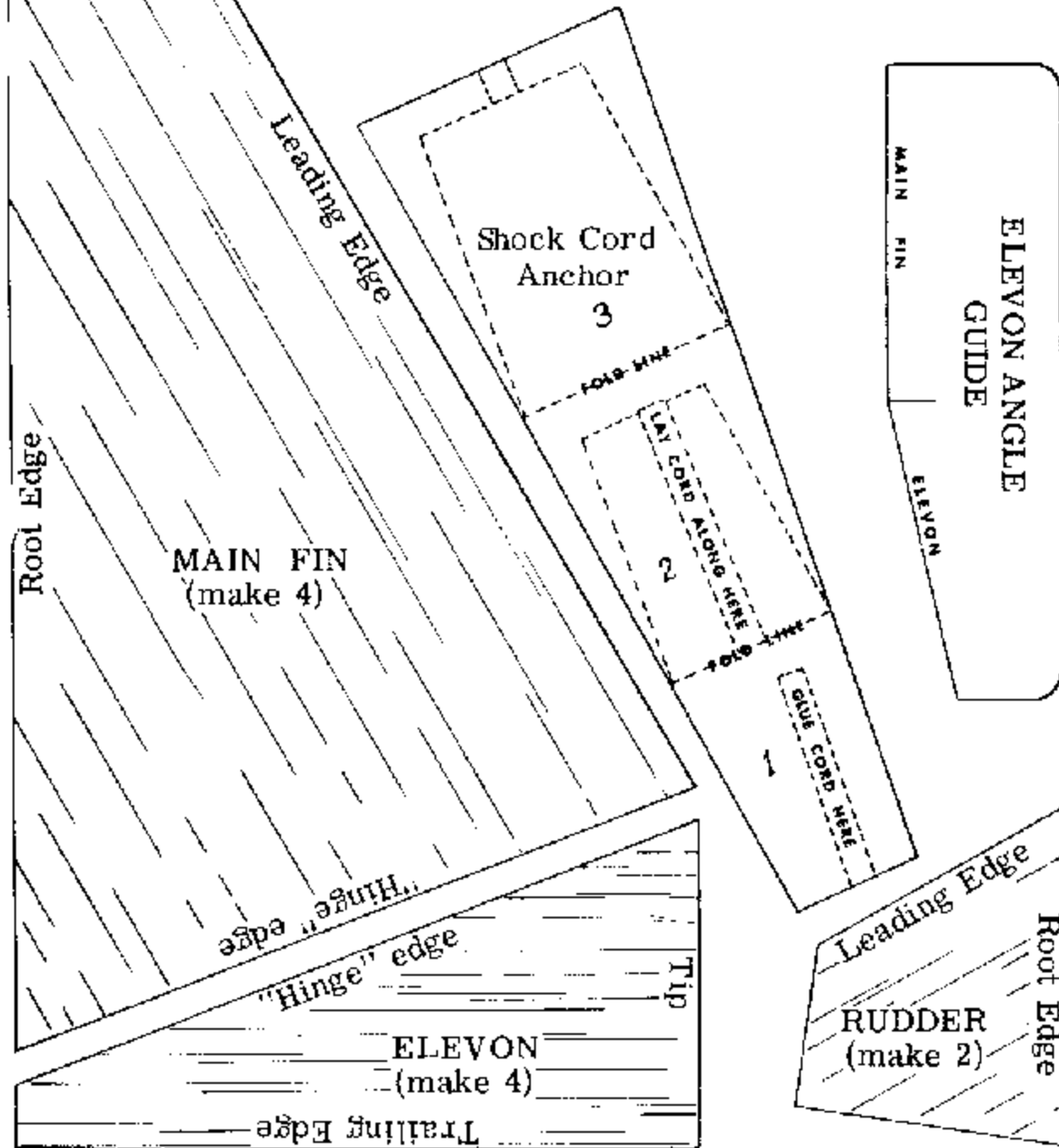

2. Slide the JT-20C into the body tube from the front. The center of the coupler should be 4" from the rear of the body tube. Drill a 1/8" hole straight thru the body tube and coupler. Ream this hole as necessary to slide a piece of 1/8" dowel (WD-1) into it at a 45° angle. Trim two pieces of dowel to the shape shown and glue them into place.

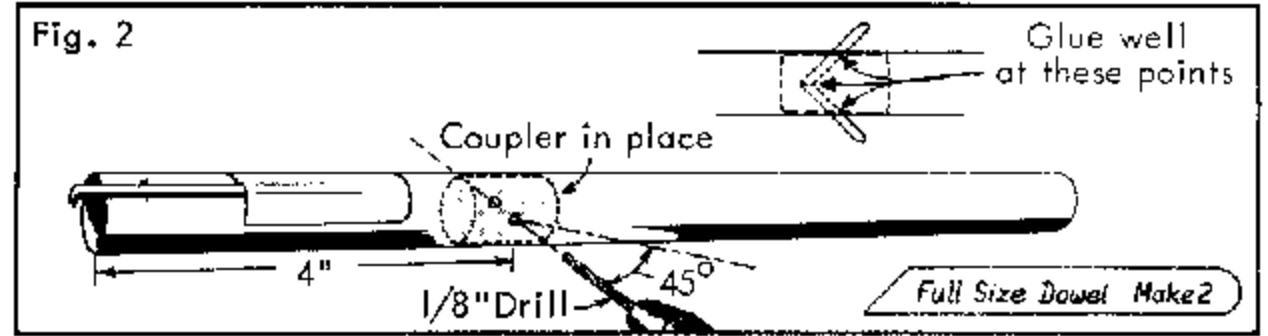

3. Trace the shock cord anchor piece (see pattern group) onto typing paper, cut out and prefold as shown. Attach this piece to one end of the shock cord following the 3 steps shown. Install the cord and anchor 3/4" into the front of the body tube. This job is made easier by using tweezers to put the unit into place, then rolling it against the inside of the body tube with a pencil or model knife handle.

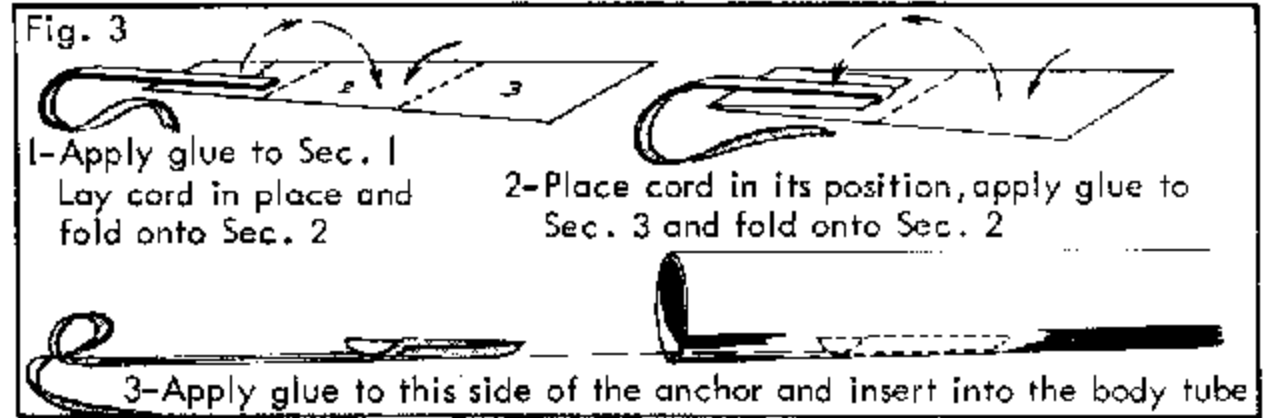

4. Thread the screw eye first thru the two nose cone weights, then into the base of the nose cone (BNC-20N). Remove only the nose cone and squirt glue into the hole and rethread the nose cone onto the screw eye until the base seats against the weights. Tape or tie on the free end of the shock cord to the screw eye.

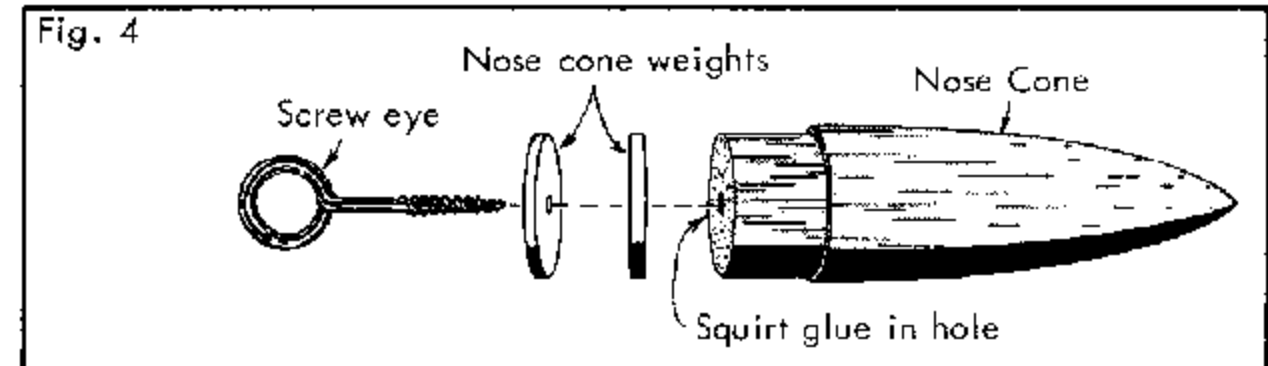

5. Prepare the parachute according to the instructions with the kit. Tie the shroud lines together at the free ends and pass the knot thru the screw eye. Divide the lines into 3's as shown, pass the nose cone up thru the "loop" thus formed and bring the lines and knot back to the screw eye and pull tight. (See the illustration.)

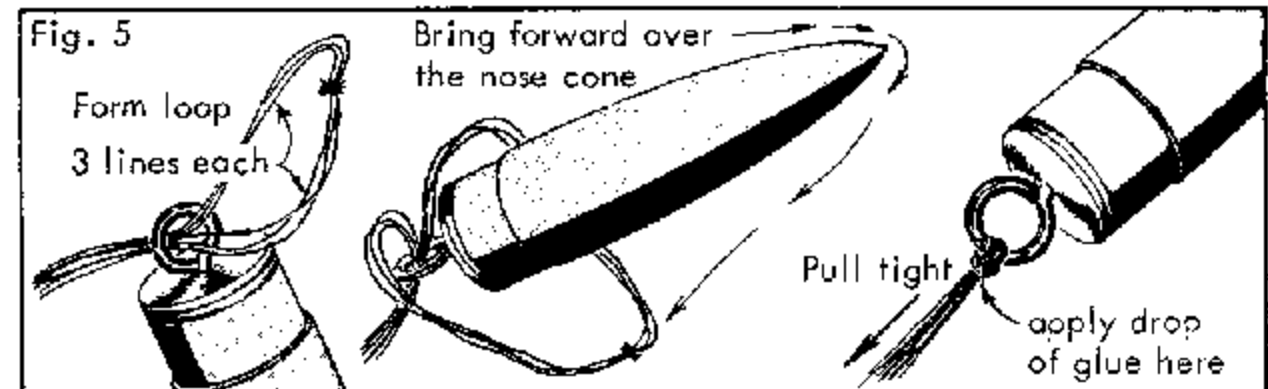

6. Cut four pieces 3/16" wide by 1" long from the 1/8" scrap balsa. Shape the pieces as shown and glue them into positions shown around the rear of the body tube. Cut two 1/16" square by 1/4" long pieces from scrap balsa and glue these small strips 1/4" ahead of the dowel pins. Cut two 1-1/4" pieces of launching lug and glue them to the body tube at positions shown. Set the entire assembly aside to dry.

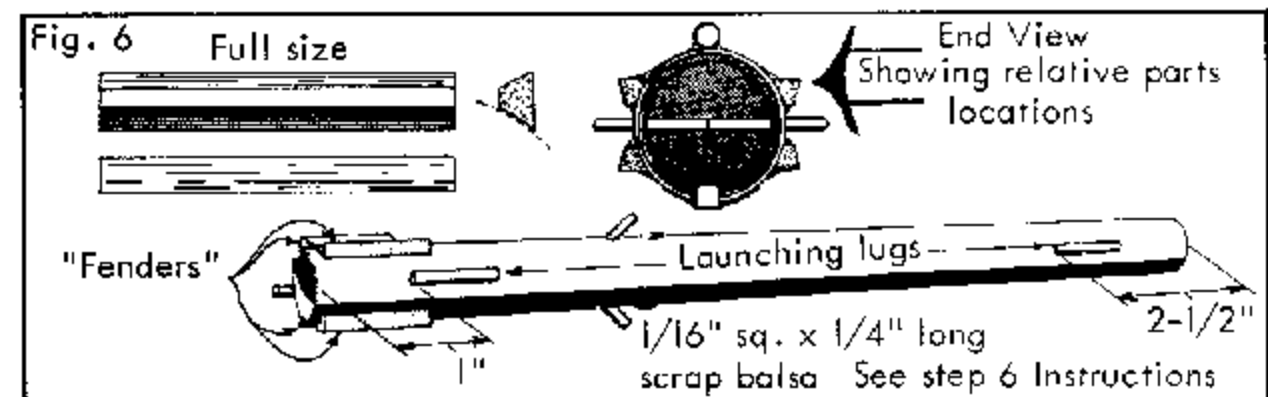

## NOW FOR THE TWINS...

7. Trace one each of the main fin, elevon and rudder from the pattern group onto stiff paper. Cut out these "templates" (as this form of master pattern is called) and lay out four main fins, four elevons and two rudders on the balsa fin stock as shown. Use a straight edge and cut out all pieces carefully with a sharp model knife. Sand the leading edges and tips of all main fins round. Sand the tips and trailing edges of all elevons round. Sand the leading edge, tip and trailing edges of both rudders round. If you have cut out all parts carefully the unsanded root edges and "hinge joint" edges should be flat and smooth.

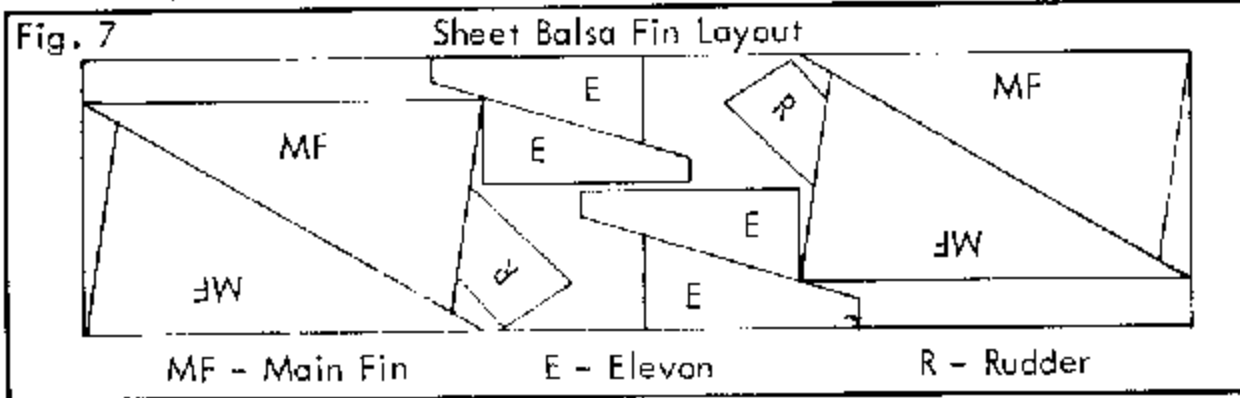

8. Apply glue to one main fin root edge and hold it for 20-30 seconds. While you wait for the glue to pass, lay one of the BT-5 body tubes on a flat surface. Place another main fin root edge against the first one and carefully lay this assembly on the body tube so the root joint is parallel to the centerline of the BT-5

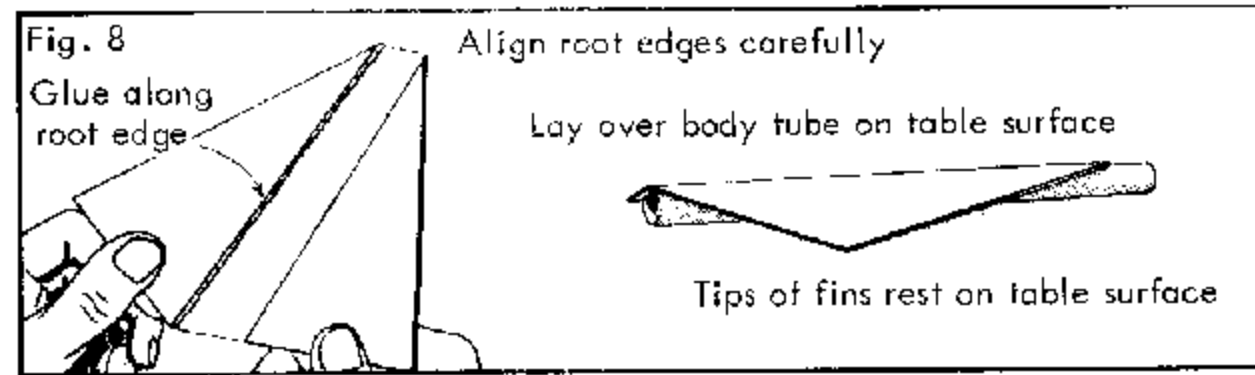

and the tips of each fin just touch the flat surface. Assemble the other pair of main fins in the same way. Allow both pairs to dry thoroughly.

9. Apply a line of glue to the root joint as shown and place the main fin assembly onto the BT-5 body tube. Do the same with the other fin assembly and body tube. Allow these joints to dry completely in the same position as before.

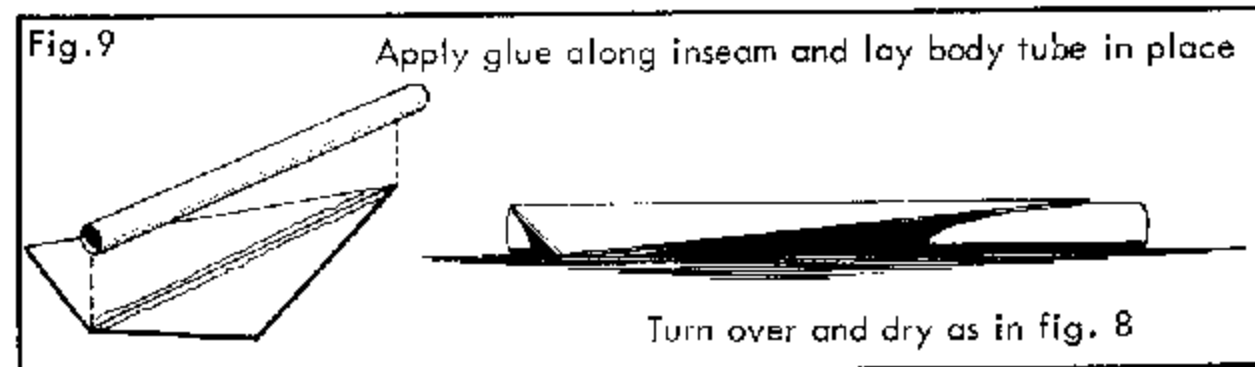

10. Cut the remainder of the LL-2C in half, angling the cut at 45° as shown. Mark the underside of one glider 3-7/8" from the rear edge of the fin assembly and drill a 1/8" hole. Ream this hole as necessary to admit a piece of the launching lug angled forward at 45° as shown. Apply a drop of glue at the point the piece of lug touches the wall of the body tube opposite the hole. Insert the launching lug into the hole until it seals against the outside wall of the body tube and in the glue just put there. Recheck the angle to be sure of its being at 45° and let dry. Apply a very small line of glue around the lug-fin joint and smooth out. Repeat this step with the other glider.

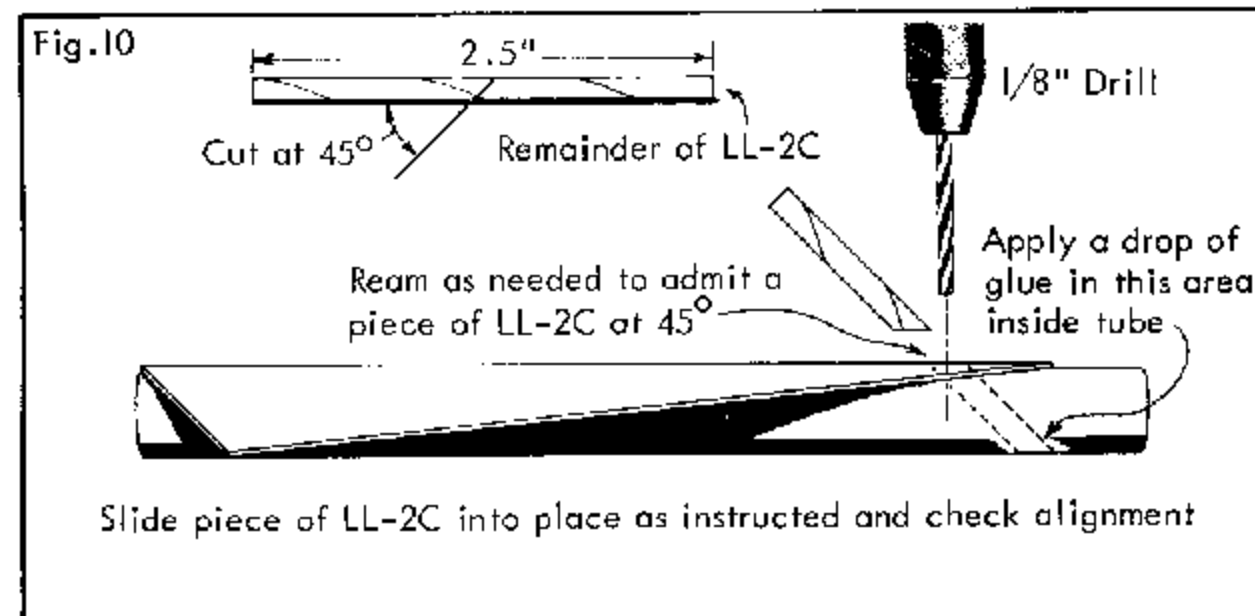

11. Apply glue just inside the front of the BT-5 body tube and install the nose cone (BNC-5E). Apply glue to the root edge of one rudder and place it as shown on the topside rear of the glider's body tube. Do the same with the other glider.

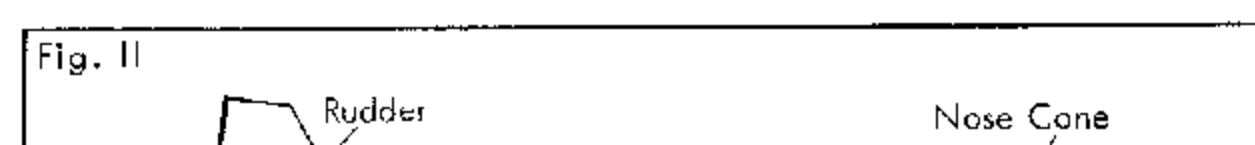

13. Apply glue to the "hinge edge" of an elevon, position the angle guide as instructed in step 12 and put the elevon in place, its flat surface resting flush with the part of the guide marked "elevon". Hold everything in its relative position until the glue has become well set. Repeat this step with the remaining three elevons. Allow to dry completely before proceeding with the next step.

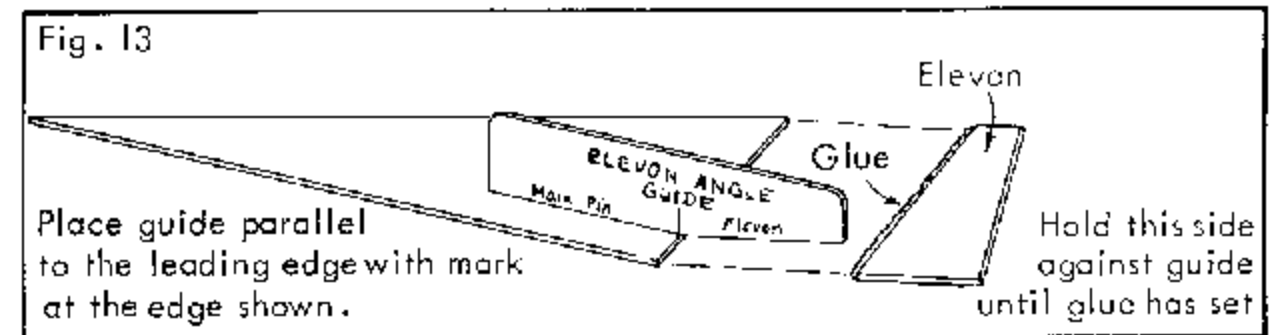

14. Apply a glue fillet to both sides of the rudder-body tube and fin-body tube joints of both birds and place them on a flat surface to dry.

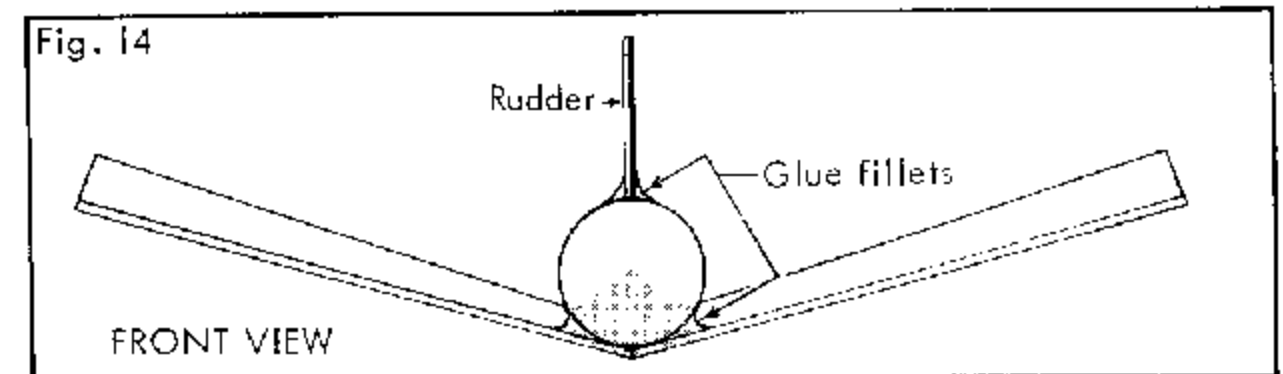

15. The SPACE TWINS need be painted only enough for good visibility. Treat the nose cones with sanding sealer, sanding between coats until all grain has been filled. A white base coat is applied to all surfaces, (mask off both dowel pins on the booster and temporarily plug the pin receivers on each bird with tissue before spraying) followed by the color coat of your choice.

16. Upward flight is standard model rocketry at its best, but before this--test glide the TWINS. On a hand launch from about shoulder height, a glide of 12 to 16 feet is normal. In event one or the other bird stalls or dives, hold the "hinge joint" close to a lighted light bulb for about 30 seconds. The glue will soften from the heat enough to allow the elevon to be adjusted up or down a few degrees as necessary to achieve a good glide. Hold the elevon at the desired angle and blow on the joint to cool and re-

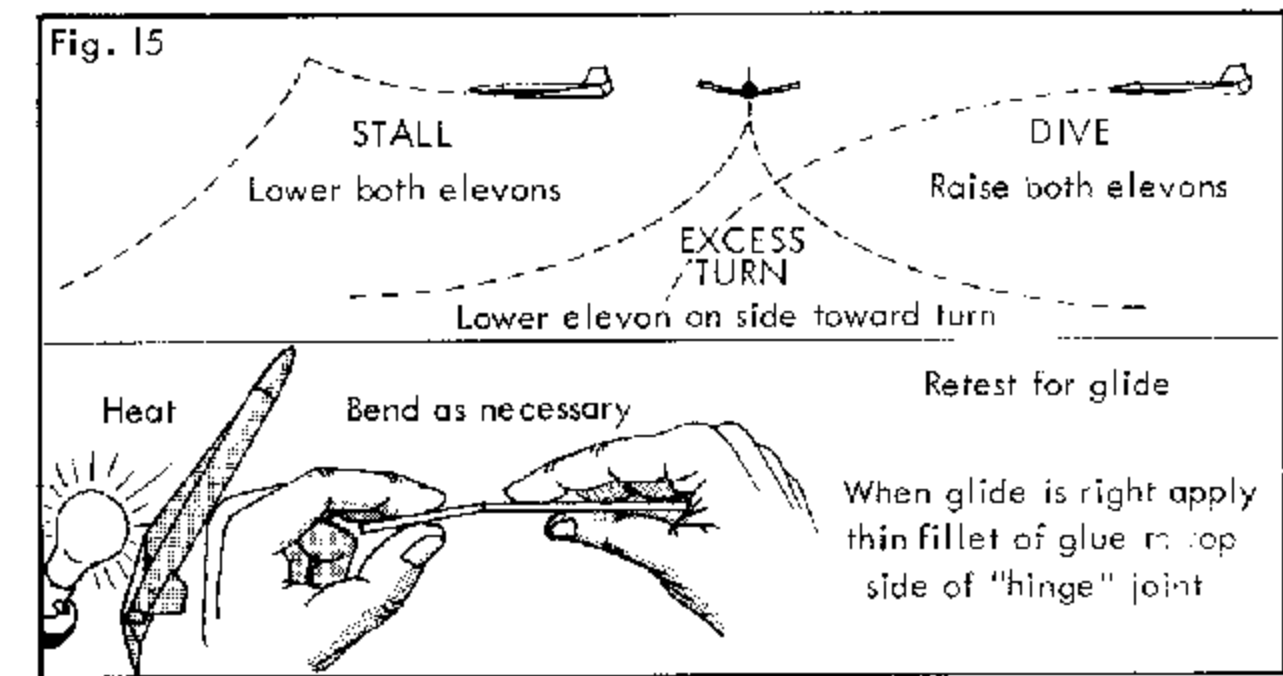

set the glue. Once this has cooled (usually 5 - 10 seconds) the joint will retain the new position. Adjusting in this fashion makes the addition of lead weight slivers unnecessary.

## COUNTDOWN CHECKLIST

10. Use two squares of flame-resistant wadding as a gas seal. Fold and stow the parachute and shroud lines and shock cord in the usual way in the booster tube, and slip the nose cone into place.

9. Prep the engine you have selected with an electrical igniter and slip it into place. The engine holder will just "snap" over the rear edge of the engine casing.

8. Place each glider on its dowel pin. Make sure the rear of each glider is centered on the support "fenders" and give each of the birds a final gentle push at the dowel pin area to be sure each glider is properly seated.

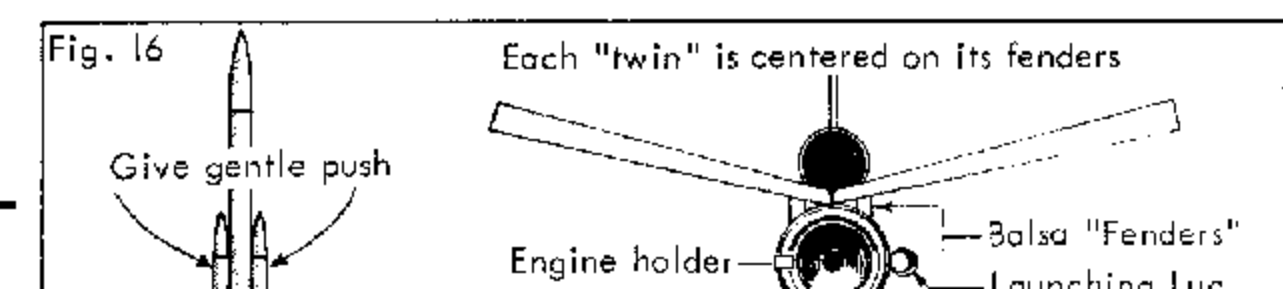

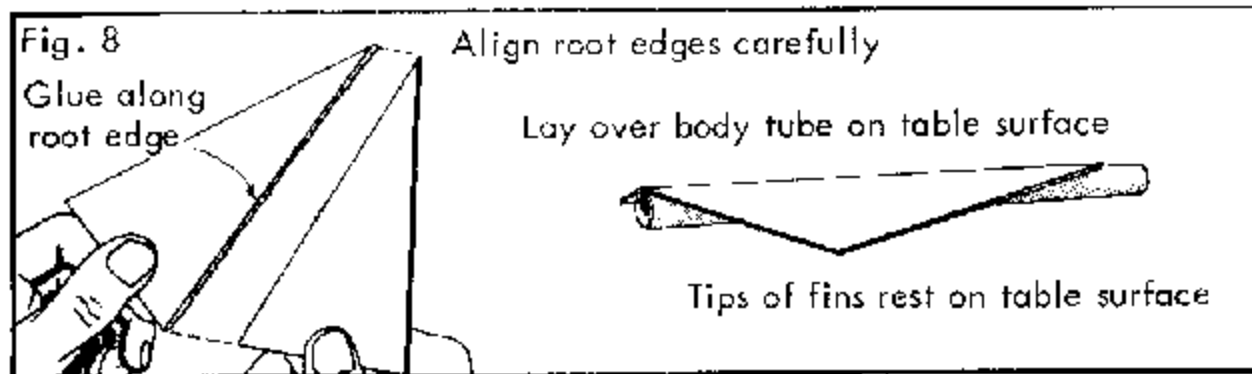

and the tips of each fin just touch the flat surface. Assemble the other pair of main fins in the same way. Allow both pairs to dry thoroughly.

- 9. Apply a line of glue to the root joint as shown and place the main fin assembly onto the BT-5 body tube. Do the same with the other fin assembly and body tube. Allow these joints to dry completely in the same position as before.

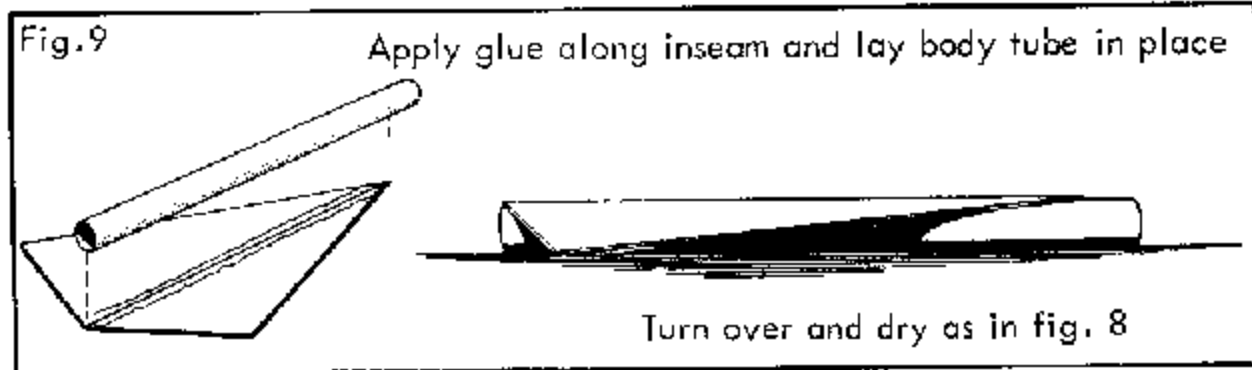

- 10. Cut the remainder of the LL-2C in half, angling the cut at 45° as shown. Mark the underside of one glider 3-7/8" from the rear edge of the fin assembly and drill a 1/8" hole. Ream this hole as necessary to admit a piece of the launching lug angled forward at 45° as shown. Apply a drop of glue at the point the piece of lug touches the wall of the body tube opposite the hole. Insert the launching lug into the hole until it seats against the outside wall of the body tube and in the glue just put there. Recheck the angle to be sure of its being at 45° and let dry. Apply a very small line of glue around the lug-fin joint and smooth out. Repeat this step with the other glider.

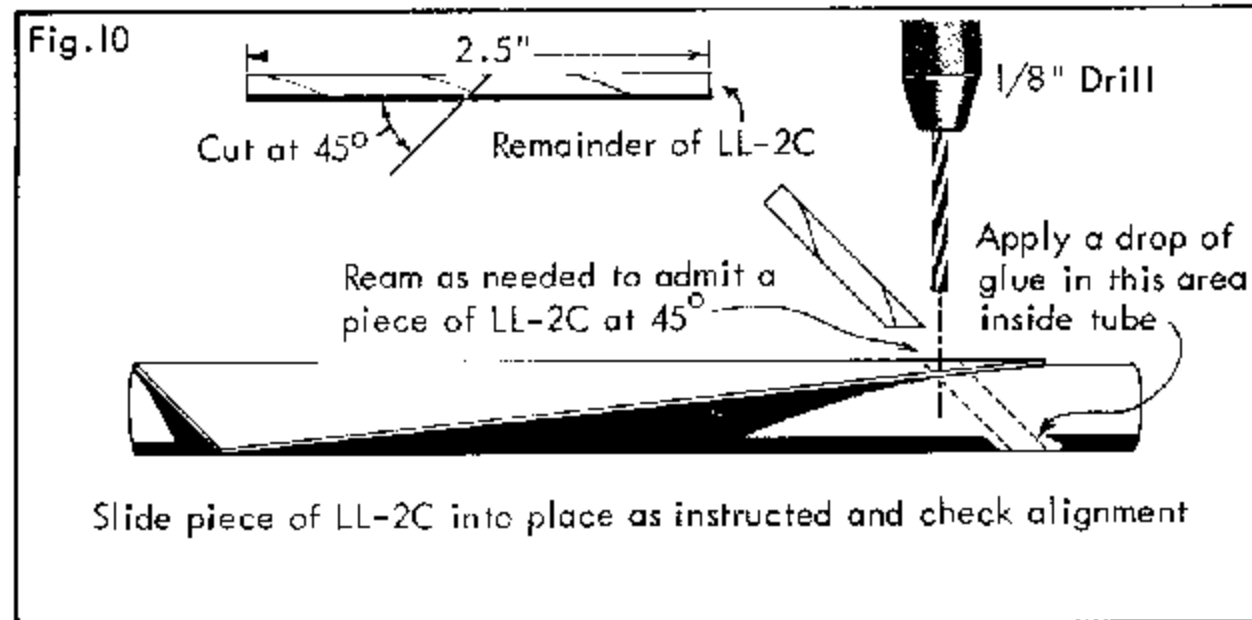

- 11. Apply glue just inside the front of the BT-5 body tube and install the nose cone (BNC-5E). Apply glue to the root edge of one rudder and place it as shown on the topside rear of the glider's body tube. Do the same with the other glider.

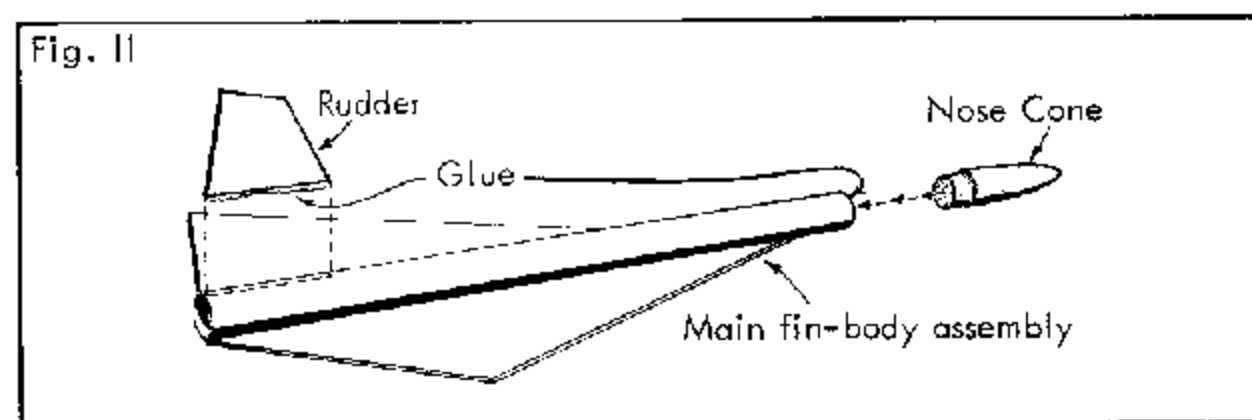

- 12. Trace the elevon angle guide onto stiff paper or cardboard and carefully cut out. Mark your template as shown. It is used by placing the half marked "main fin" on the main fin parallel to the leading edge and holding it there while positioning the elevon.

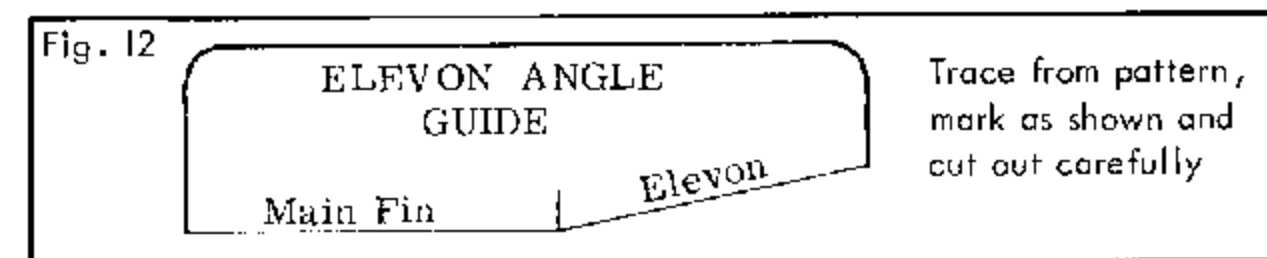

- 15. The SPACE TWINS need be painted only enough for good visibility. Treat the nose cones with sanding sealer, sanding between coats until all grain has been filled. A white base coat is applied to all surfaces, (mask off both dowel pins on the booster and temporarily plug the pin receivers on each bird with tissue before spraying) followed by the color coat of your choice.

- 16. Upward flight is standard model rocketry at its best, but before this--test glide the TWINS. On a hand launch from about shoulder height, a glide of 12 to 16 feet is normal. In event one or the other bird stalls or dives, hold the "hinge joint" close to a lighted light bulb for about 30 seconds. The glue will soften from the heat enough to allow the elevon to be adjusted up or down a few degrees as necessary to achieve a good glide. Hold the elevon at the desired angle and blow on the joint to cool and re-

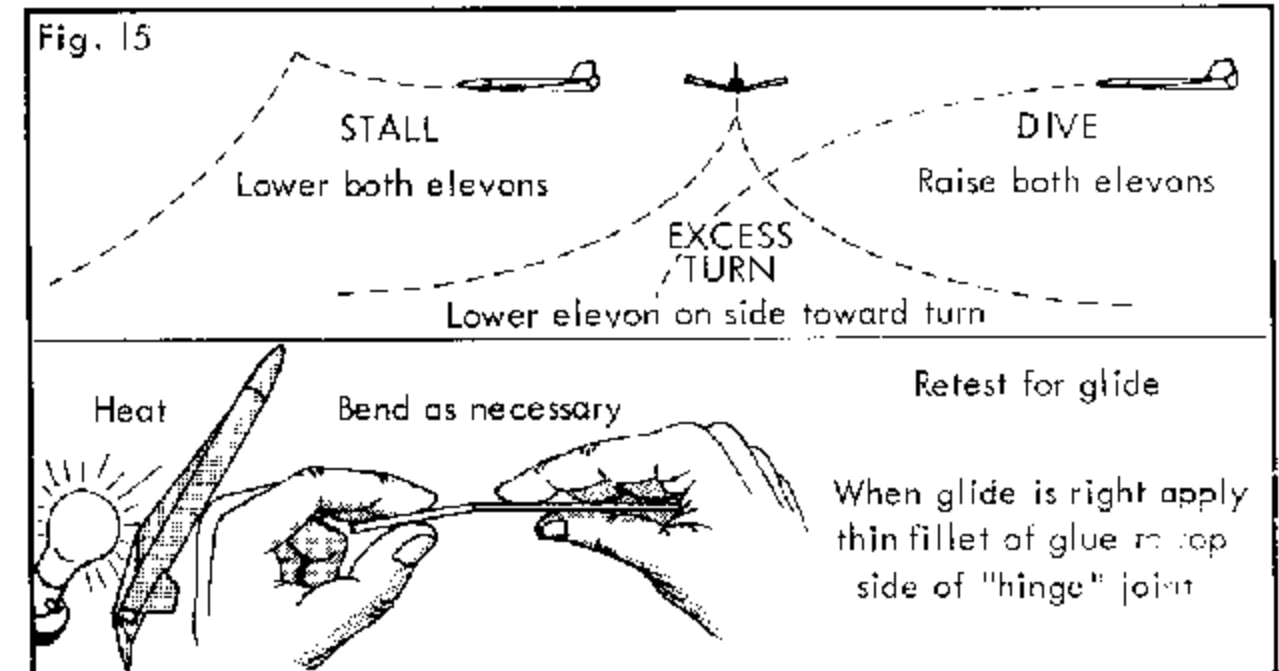

set the glue. Once this has cooled (usually 5 - 10 seconds) the joint will retain the new position. Adjusting in this fashion makes the addition of lead weight slivers unnecessary.

## COUNTDOWN CHECKLIST

- 10. Use two squares of flame-resistant wadding as a gas seal. Fold and stow the parachute and shroud lines and shock cord in the usual way in the booster tube, and slip the nose cone into place.
- 9. Prep the engine you have selected with an electrical igniter and slip it into place. The engine holder will just "snap" over the rear edge of the engine casing.
- 8. Place each glider on its dowel pin. Make sure the rear of each glider is centered on the support "fenders" and give each of the birds a final gentle push at the dowel pin area to be sure each glider is properly seated.

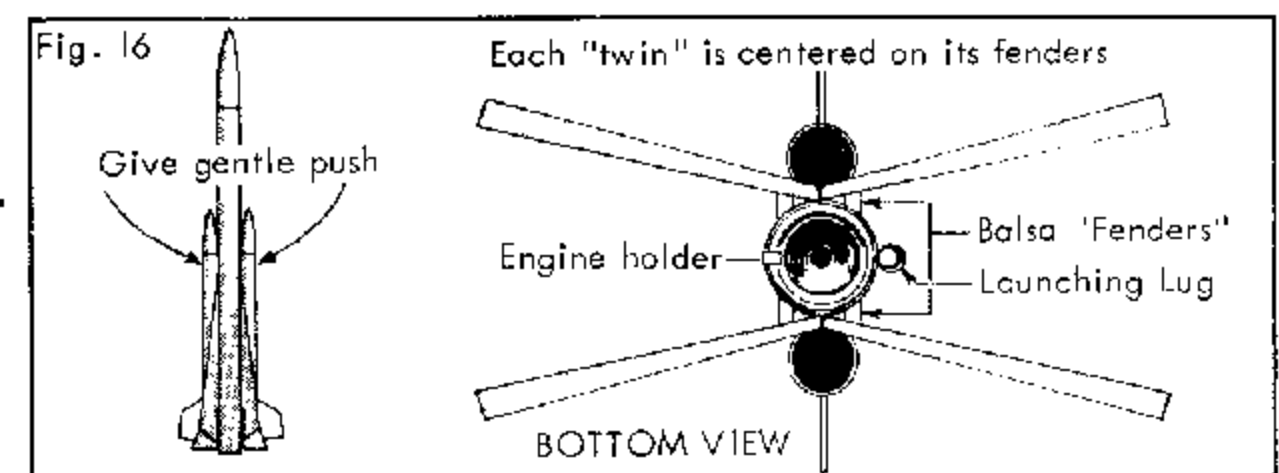

- 7. Slide the model down the launch rod (check for, and correct any binding tendency along the rod) make sure the safety key is out of the controller and connect the micro-clips to the igniter leads. (Remember -- clip 'em as close to the engine nozzle as possible.)
- 6. Alert tracking and recovery crews. Check the area for low flying aircraft and if all clear, start your final countdown.
- 5- -4- -3- -2- -1- START\*

\* This term is becoming internationally accepted as a replacement for the term "LAUNCH".