

# QUEST WICK KIT

Ready to launch in  
15 to 45 minutes.

# SEEKER™

No. 1611

Plastic  
Nose  
Cone  
20157

## ASSEMBLY INSTRUCTIONS

TOOLS YOU'LL NEED TO ASSEMBLE THIS ROCKET

Tube Type Plastic Cement

Hobby Knife

Body Tube  
11410

Transition  
21084

Transition  
Base  
20312

Payload  
Tube  
11314

White Shock Cord  
50012

Yellow Shock Cord  
50053

Custom  
Parts  
21698

Fin  
20801 (4)

Motor  
Housing  
20606/20607

Gripper Tabs  
00500 (2)

14" Parachute  
28107 (2)

Gray Motor  
Mount Tube  
10301

Display  
Stand  
24208/24209

26" Shroud Lines  
50100 (2)

Decal Sheet  
3-01611-1030

Fin  
Locking  
Ring  
20023

Motor Lock Ring  
20024

Fin

PARTS NOT TO SCALE

1

Yellow  
Kevlar  
Shock  
Cord

White  
Elastic  
Shock  
Cord

A. Hold the Yellow and White Cords side by side with the ends even.

B. Tie an over-hand knot to join the cords.

C. Pass Yellow Cord through loop in Motor Housing.

D. Tie a double knot.

2

A. Position slot in Gray Motor Mount Tube over tab on Motor Housing.

B. Glue the two Motor Housing halves together.

C. Feed Yellow and White Cord through the Body Tube.

D. Apply glue around inside of Body Tube and insert Motor Housing until it seats against the Body Tube.

3-01611-1010

**3**

A. Test fit all four Fins into the slots.

B. Remove each one, add glue and replace.

Check Fin alignment

C. Twist Fin Locking Ring onto rear of Motor Housing.

D. Tie a figure "8" knot in the loose end of the White Shock Cord with a 1 inch loop as shown.

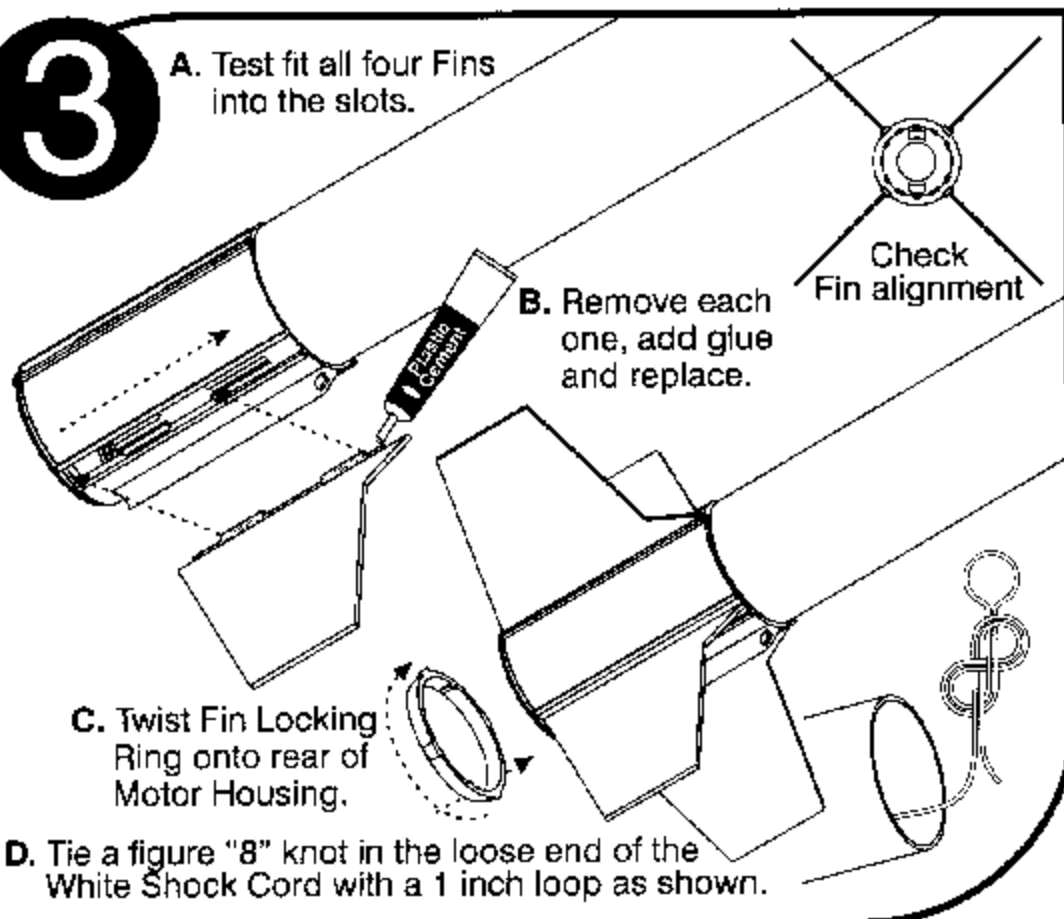
**4**

A. Apply Glue around inside edge of plastic transition.

B. Push base into transition.

C. Apply glue around inside edge of Payload Tube and push Transition into place.

D. Position Nose Cone in end of Tube. DO NOT GLUE!

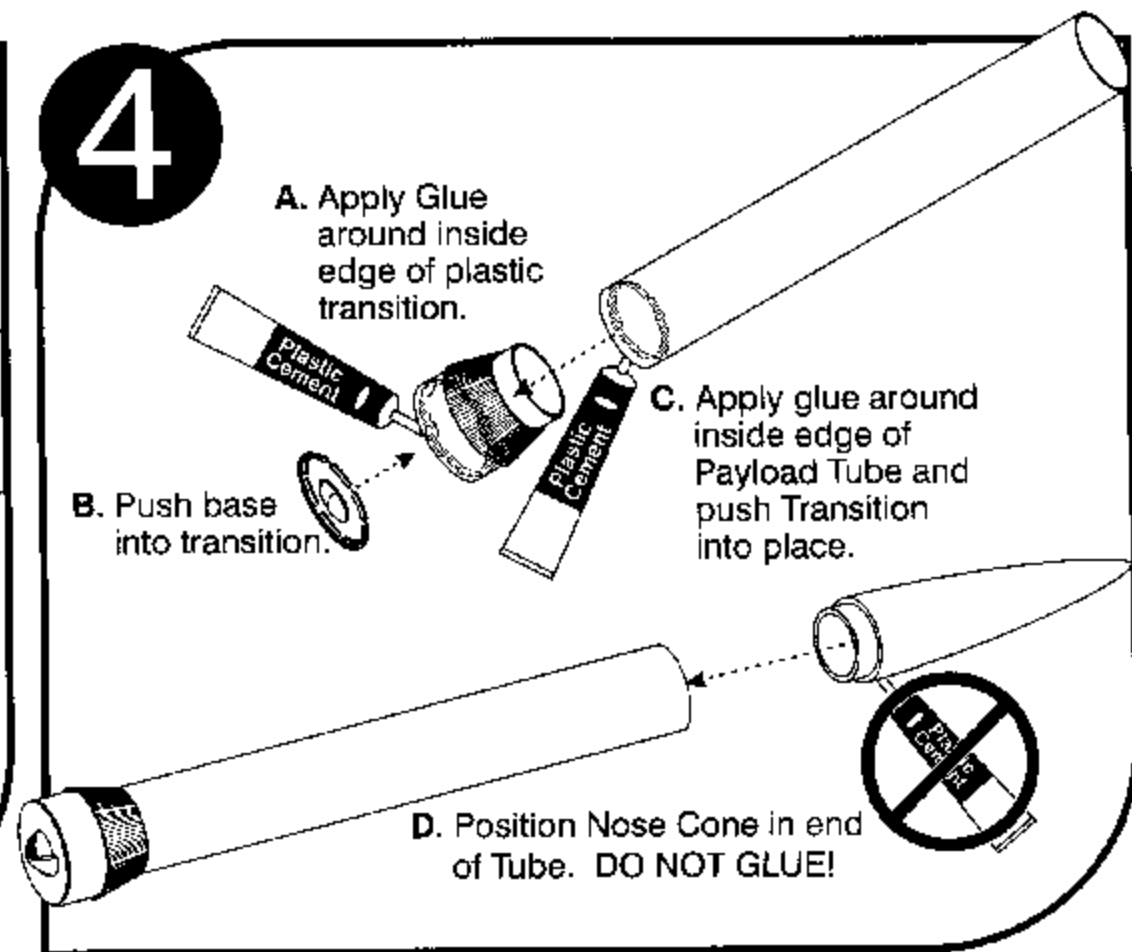
**5**

A. Place one Gripper Tab on each of the six corners on Parachute.

B. Firmly squeeze each Gripper to the Parachute with your fingers.

C. Tie Shroud Line with a double knot.

Repeat A-C for second Parachute

D. Attach ONE Parachute to eyelet in Coupler Base.

E. Attach ONE Parachute to loop in White Shock Cord.

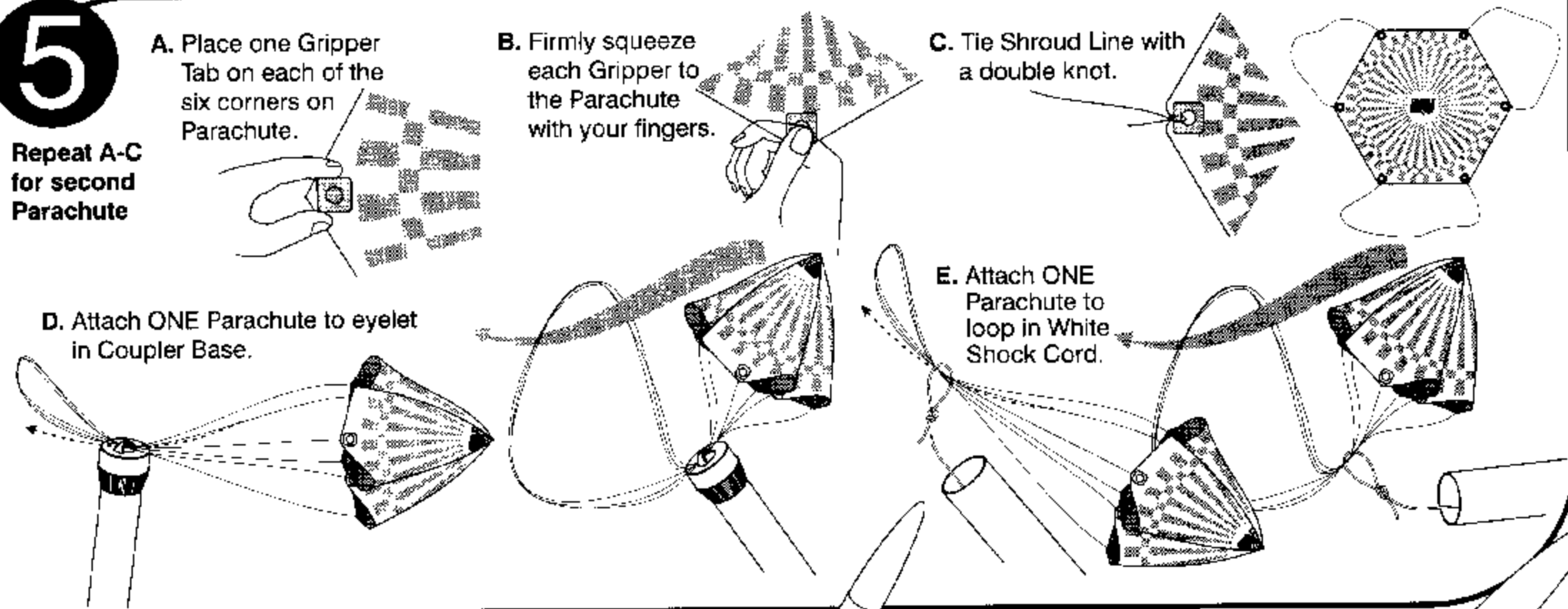
**6**

A. Grab Parachute at center - pull gently.

B. Fold.

C. Roll.

D. Insert rolled Parachute, then Shock Cord and slide Nose Cone into place.

PARACHUTE MUST SLIDE EASILY INTO THE TUBE.

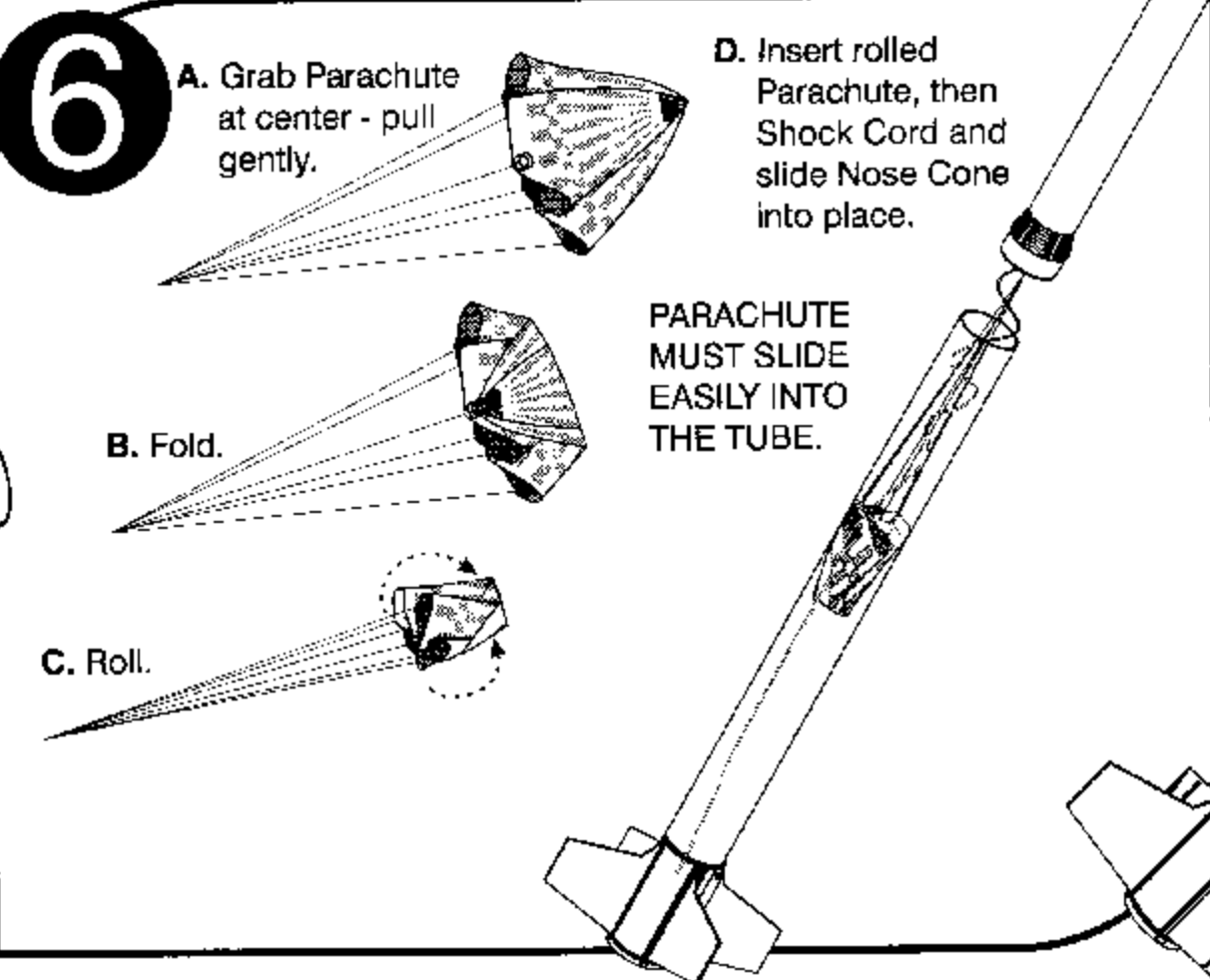
**7**

A. Remove the self-adhesive decals one at a time.

B. Position on rocket.

C. Rub gently.

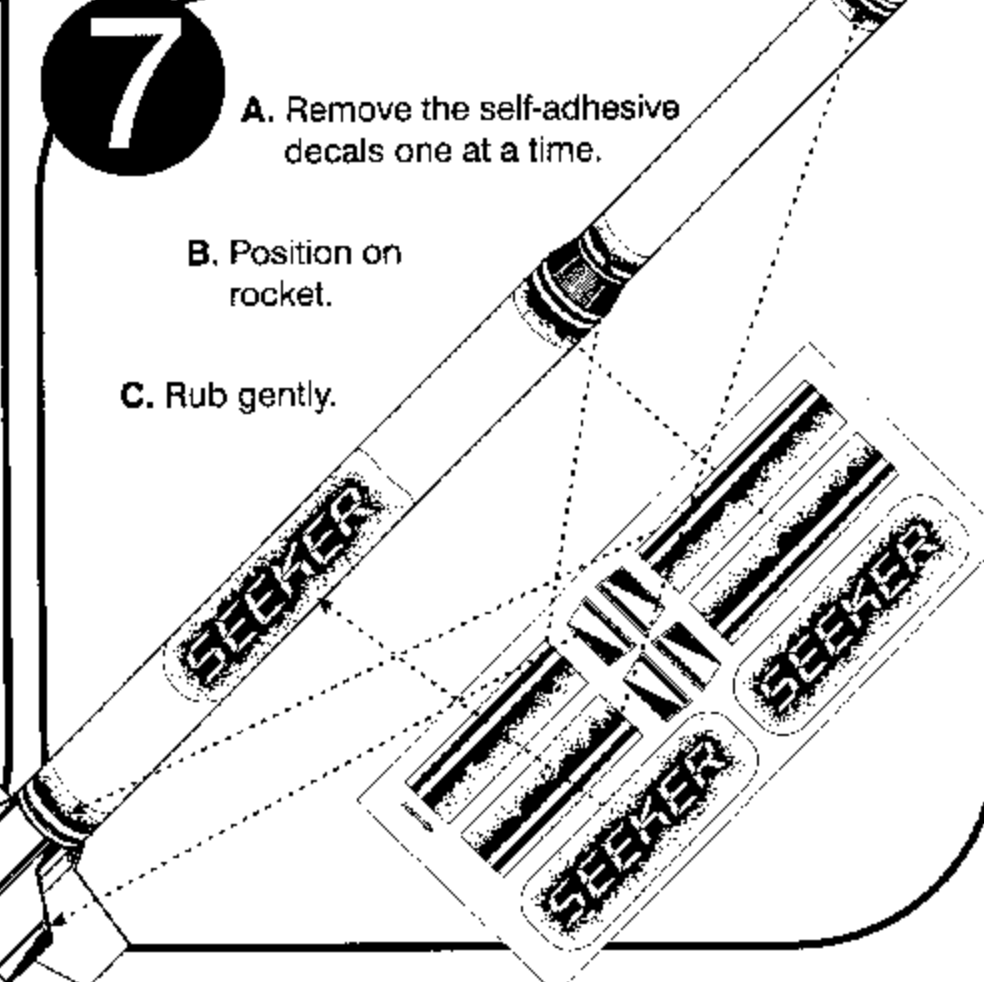

## Displaying Your Rocket

- A. Slide two halves of display stand together.



- B. Slide Rocket Motor Mount onto Display Stand.

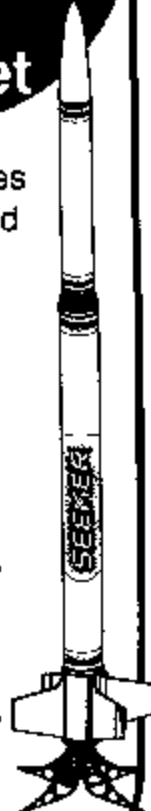

## Customizing Your Rocket

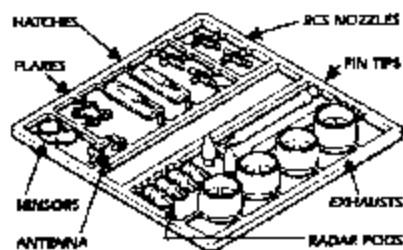

- A. Use the kit package as your guide.  
 B. Use a hobby knife to remove parts.  
 C. Glue each in place.

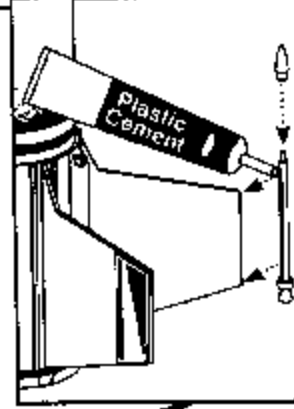
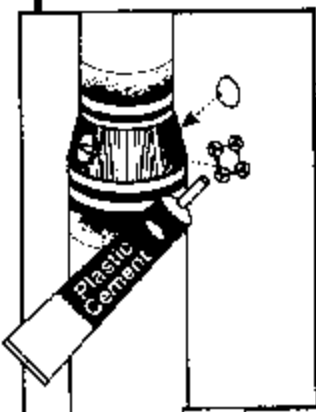

# FLYING YOUR ROCKET

## Supplies You Will Need to Launch Your Rocket:

- Quest Launch Pad (No. 7610)  
 Quest Launch Controller (No. 7510)  
 Quest Parachute Recovery wadding (No. 7020)  
 Quest Rocket Motors Type A6-4, B6-4, C6-3, C6-5.  
 Use A6-4 Motor for your first flights.

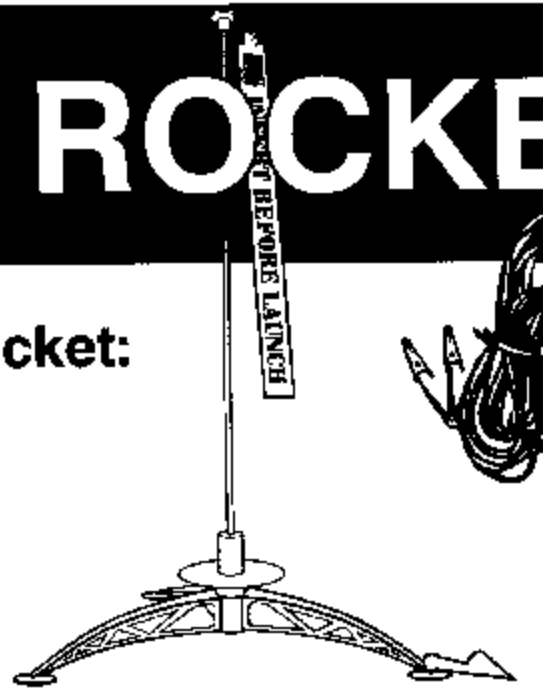

## 1 Pack Your Parachute

- A. Remove Nose Cone and Parachute.  
 B. Crumple and insert THREE squares of Recovery Wadding.  
 C. Re-pack Parachute, Shock Cord, and replace Nose Cone.  
 See Step 6 of Assembly Instructions for Parachute folding.

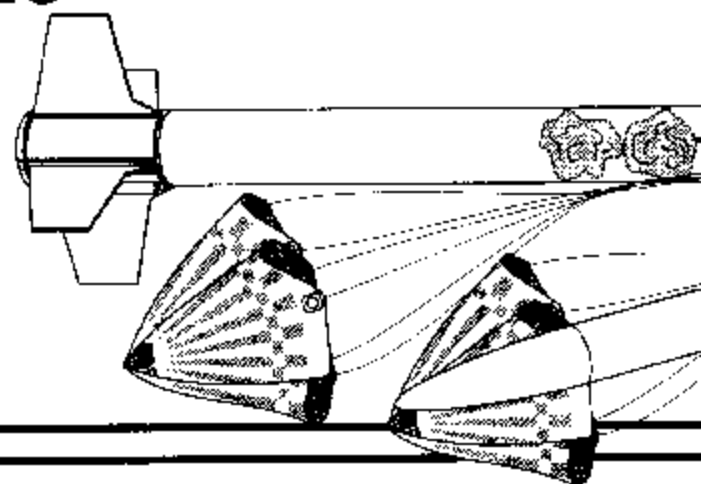

## 2 Install Igniter and Rocket Motor

- A. Remove Tiger Tail Sticker.  
 B. Center the Ignition Wire.  
 C. Fold Tiger Tail Sticker over the Wire.  
 D. Place Igniter Assembly into Motor Nozzle as far as it will go.  
 E. Push in the plastic Tiger Tac.  
 F. Insert Rocket Motor and Igniter into the rocket.  
 G. Twist plastic Motor Lock Ring to hold Motor in place.

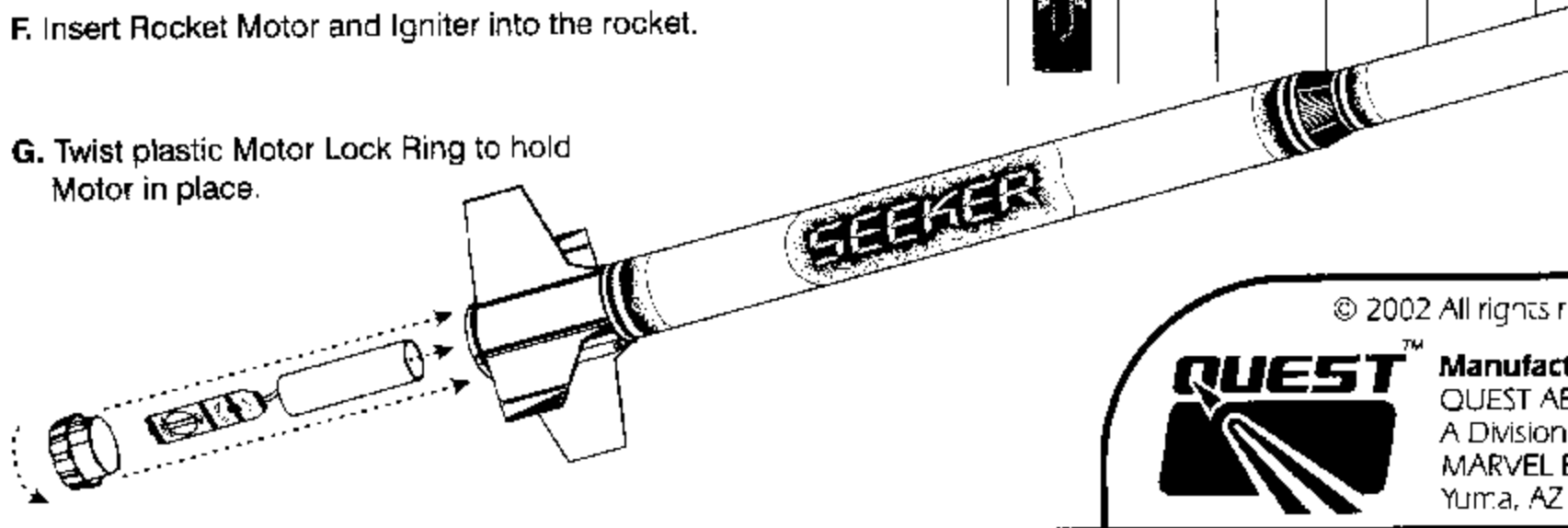
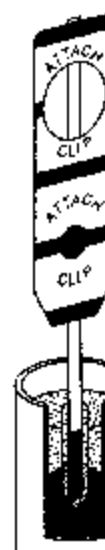
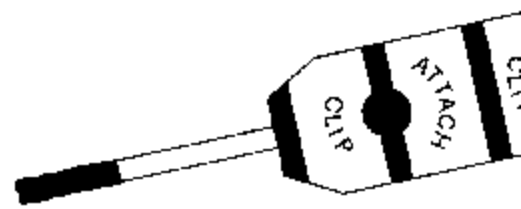
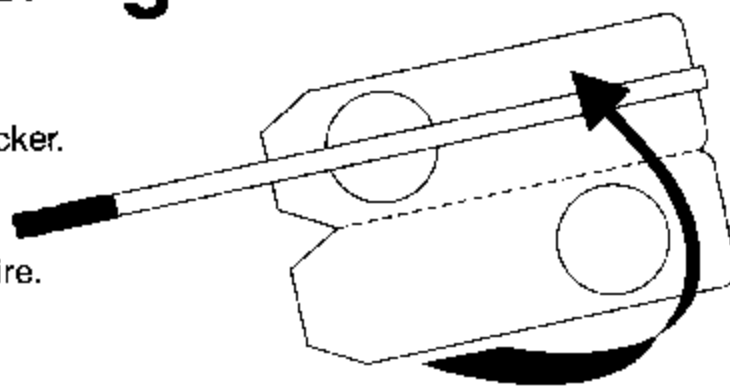

© 2002 All rights reserved.



Manufactured by  
 QUEST AEROSPACE  
 A Division of  
 MARVEL  
 Yuma, AZ

ET

# 3

## Launch Procedures

### Launch Site Selection:

- Pick a large area away from tall trees, power lines and low flying aircraft. The larger your launch area the easier it will be to recover your rocket. A circular area of at least 200 feet in diameter is recommended.
- Launch area must be clear of brown grass or dry weeds.

A. Remove Rod Safety Cap.

B. Be certain Safety Key is with you and not in Launch Controller.

C. Slide rocket down Launch Rod.

D. Attach one micro clip to each hole where the igniter is exposed. Be sure that the clips do not touch each other.

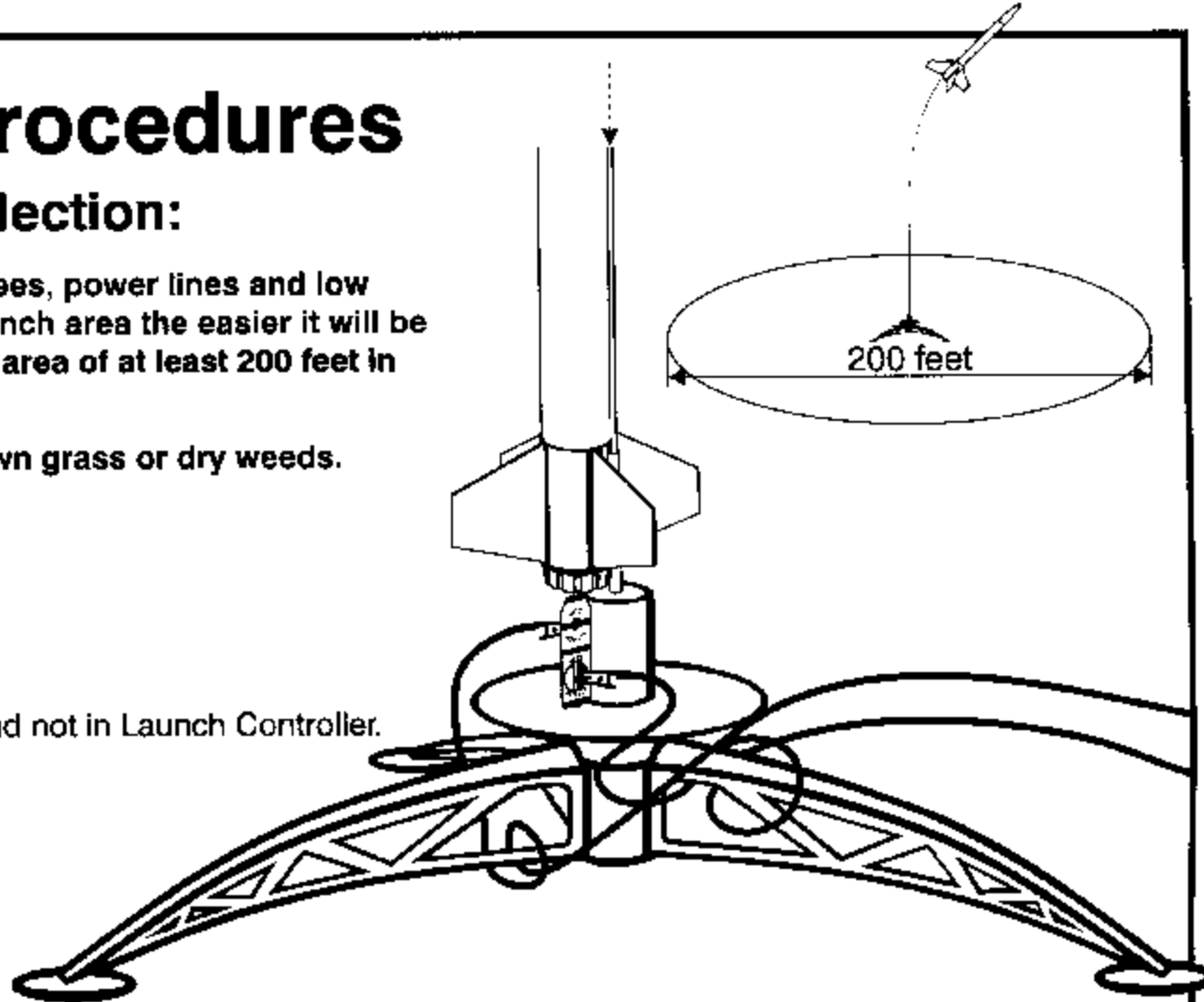

### Count Down Procedure:

A. Move yourself and all spectators away from Rocket and Launch Pad as far as the wire will allow (15 feet).

B. Wind conditions should be gentle. Make sure the sky is clear of low flying aircraft.

C. Insert Safety Key to arm Launch Controller.

D. In a LOUD voice, begin count down: 5...4...3...2...1...LIFT OFF!  
Press and hold the Launch button until the Rocket Motor starts, then release.

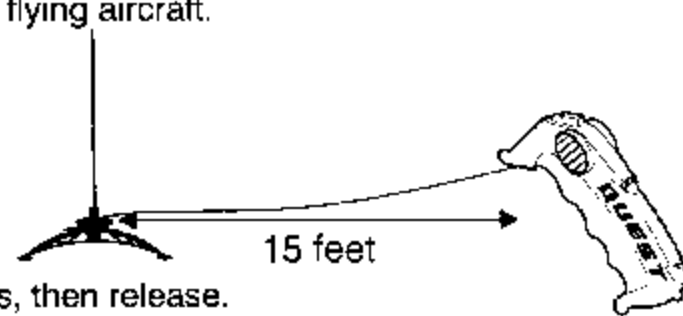

E. Remove the Safety Key from Launch Controller as soon as rocket lifts off.

F. Replace the Launch Rod Safety Cap between launchings.

### Misfire Procedure:

If the rocket motor fails to ignite:

A. Remove the Safety Key.

B. Wait ONE MINUTE before approaching the Rocket. Carefully remove rocket.

C. Remove rocket motor and old igniter. Install a new Tiger Tail Igniter in the Motor and reinstall.

D. Use a small emery board or sandpaper to clean the inside surfaces of the micro clips.

E. Repeat the Launch Procedure and Count Down.

rights reserved

Manufactured by:  
AEROSPACE  
Division of  
MODEL ENTERPRISES, INC.  
AZ 85364

Always follow the National Association of Rocketry,  
(NAR) Model Rocket Safety Code while using your model  
rocket. It is printed on the back of the package panel.

Customer Service:  
800 858-7302